

**HP 8935 Series  
E6380A CDMA Cellular/PCS Base Station  
Test Set  
AMPS Base Station Tests**

**Application Guide**

**Firmware Version: A.01.10 and above**

HP Part Number: E6380-90017

**Revision B**

**Printed in U.S.A**

**June 1998**

© Copyright Hewlett-Packard Company 1997, 1998



---

## **Notice**

Information contained in this document is subject to change without notice.

All Rights Reserved. Reproduction, adaptation, or translation without prior written permission is prohibited, except as allowed under the copyright laws.

This material may be reproduced by the U.S. Government pursuant to the Copyright License under the clause at DFARS 52.227-7013 (APR 1998).

<b>In This Manual and Regulatory Information</b> .....	<b>5</b>
<b>1. Getting Started with AMPS Test</b>	
About the Test Set .....	18
Product Description .....	18
Batteries .....	18
Getting Help .....	19
What's Included with this Test Set .....	20
Manual and Automatic Operation Modes .....	21
IBASIC programs .....	21
Maximizing the Accuracy of Your Measurements .....	22
Calibration .....	22
TX Power Temperature Compensation .....	22
Display an FM Carrier Signal (Loopback Test) .....	23
Connections for FM Carrier Loopback Test .....	23
Get Started with the Test Set .....	24
Preparing the Test Set .....	24
Generate an FM Carrier Signal .....	24
Analyzing an FM Carrier Signal .....	26
What to Do Next .....	27
<b>2. Testing AMPS Base Stations</b>	
AMPS Tests You Can Perform .....	30
What You Need to Know to Begin .....	31
Connecting the Test Set to Your Base Station .....	32
Compensating for Signal Losses and Gains in the Test Setup .....	33
Transmitter Frequency Error/Offset and Power Test .....	34
Prerequisites .....	34
Begin Testing .....	34
Transmitter SAT Frequency and Deviation .....	36
Prerequisites .....	36
Test Procedure .....	36
Transmitter Data Deviation .....	38
Prerequisites .....	38
Test Procedure .....	38
Transmitter Maximum Voice Deviation .....	40
Prerequisites .....	40
Test Procedure .....	40
Receiver Sensitivity (SINAD) .....	42
Prerequisites .....	42
Test Procedure .....	42
Receiver Squelch Threshold .....	45
Prerequisites .....	45
Test Procedure .....	45
<b>3. Utility Procedures</b>	
Beeper .....	50
Beeper Control .....	50

---

# Contents

Measuring Insertion Losses . . . . .	51
Memory Cards . . . . .	52
Memory Cards and Intialization . . . . .	52
Oscilloscope . . . . .	53
Selecting the Oscilloscope's Input . . . . .	54
Selecting the Oscilloscope's Filters . . . . .	54
Triggering the Oscilloscope . . . . .	55
Using the Marker . . . . .	56
Online Help . . . . .	57
Help Screen Display . . . . .	57
Ports: HP-IB, Serial and Parallel . . . . .	58
HP-IB Port . . . . .	58
Serial Ports . . . . .	58
Parallel Ports . . . . .	60
Printing . . . . .	61
Configuring the Test Set for Printing . . . . .	61
Printing a Screen . . . . .	61
Measuring Swept Return Loss . . . . .	62
Tracking Generator . . . . .	65
Using the Tracking Generator. . . . .	65
User Keys . . . . .	66
Displaying the Pre-assigned Local User Keys . . . . .	66
Assigning a Local User Key . . . . .	66
Assigning a Global User Key . . . . .	67
To Release a User Key Assignment. . . . .	67
Using Channel Numbers to Set Analyzer and Generator Frequencies	68
RF Chan and Tune Freq Fields . . . . .	69
Voltmeter . . . . .	70
Measuring AC Level and DC Level. . . . .	70

---

## In This Manual and Regulatory Information

### What is Discussed This Manual

This manual explains how to use the HP 8935 Series E6380A Test Set to manually test an AMPS base station.

This document presents a step-by-step approach to AMPS base station testing using the Test Set, including what you need to know before you can start testing.

### What is Not Discussed in this Manual

- General operation of the Test Set.

Changing display screens and their associated controls is discussed in the Reference Guide (HP part number E6380-90019).

- Detailed operation of the Test Set's spectrum analyzer and oscilloscope.

Although there are basic explanations in this manual, more detail is provided in the Reference Guide concerning the various control menus and fields available.

- How to control your base station, switch system, or any other software or hardware associated with your cell site equipment.

Each manufacturer and cellular service provider has their own cell site control and base station configuration procedures that go beyond the scope of this documentation.

- How to perform IBASIC programming operations, such as writing, editing, copying, or cataloging programs.

Programming the Test Set is explained in the *Programming Manual* (HP part number E6380-90018), and the IBASIC language is explained in the *HP Instrument BASIC User's Handbook* (HP part number E2083-90005).

### Conventions Used in This Manual

The following conventions are used throughout this manual to help clarify instructions and reduce unnecessary text:

**Test Set** refers to the HP 8935 Series E6380A CDMA Cellular/PCS Base Station Test Set.

Test Set keys are indicated like this: **Preset**

Test Set screen information, such as a measurement result or an error message, is shown like this: TX Power 7.21 W

**Which Document is Required?** The following documents are part of the Test Set's document set. Use the table to help you decide which document you need.

**Table 1 Document Navigation**

<b>Document</b>	<b>Part Number</b>	<b>Usage</b>
CDMA Application Guide	E6380-90016	Use this manual for basic CDMA measurements and for getting started with the Test Set.
AMPS Application Guide	E6380-90017	Use this manual for making AMPS base station measurements.
Reference Guide	E6380-90019	Use this manual for screen and field descriptions and general operation information about the Test Set.
HP-IB Syntax Reference Guide	E6380-90073	Use this manual to learn HP-IB syntax for the Test Set.
Programmer's Guide	E6380-90018	Use this manual to learn how to write programs for the Test Set.
Assembly Level Repair Guide	E6380-90015	Use this manual to perform calibration on the Test Set and for general service information.
CD-ROM	E6380-90027	All user documentation

### **Manufacturer's Declaration**

This statement is provided to comply with the requirements of the German Sound Emission Directive, from 18 January 1991.

This product has a sound pressure emission (at the operator position) < 70 dB(A).

- Sound Pressure  $L_p < 70 \text{ dB(A)}$

**At Operator Position**

**Normal Operation**

According to ISO 7779:1988/EN 27779:1991 (Type Test).

### **Herstellerbescheinigung**

Diese Information steht im Zusammenhang mit den Anforderungen der Maschinenlärminformationsverordnung vom 18 January 1991.

Schalldruckpegel  $L_p < 70 \text{ dB(A)}$ .

**Am Arbeitsplatz**

**Normaler Betrieb.**

Nach ISO 7779:1988/EN 27779:1991 (Typprüfung).

This product and related documentation must be reviewed for familiarization with safety markings and instructions before operation.

## Safety

### GENERAL

This product has been designed and tested in accordance with IEC Publication 1010, "Safety Requirements for Electronic Measuring Apparatus," and has been supplied in a safe condition. This instruction documentation contains information and warnings which must be followed by the user to ensure safe operation and to maintain the product in a safe condition.

### SAFETY SYMBOLS



Indicates instrument damage can occur if indicated operating limits are exceeded. Refer to the instructions in this guide.



Indicates hazardous voltages.



Indicates earth (ground) terminal

---

#### WARNING

**A WARNING note denotes a hazard. It calls attention to a procedure, practice, or the like, which, if not correctly performed or adhered to, could result in personal injury. Do not proceed beyond a WARNING sign until the indicated conditions are fully understood and met.**

---

---

#### CAUTION

A CAUTION note denotes a hazard. It calls attention to an operation procedure, practice, or the like, which, if not correctly performed or adhered to, could result in damage to or destruction of part or all of the product. Do not proceed beyond an CAUTION note until the indicated conditions are fully understood and met.

---

### Safety Considerations for this Instrument



---

**WARNING**

**This product is a Safety Class I instrument (provided with a protective earthing ground incorporated in the power cord). The mains plug shall only be inserted in a socket outlet provided with a protective earth contact. Any interruption of the protective conductor inside or outside of the product is likely to make the product dangerous. Intentional interruption is prohibited.**



**Do not expose to or operate this instrument in outdoor atmospheric conditions such as direct rain, hail, sleet, snow, icing, sunshine or wind. Operate this instrument only within its specified temperature humidity conditions.**



**This instrument is equipped with internal ground fault circuit interrupter class A.**

- **This device does not protect against electrical shock due to contact with both circuit conductors or a fault in supply wiring to product.**
- **Do not use extension cord to connect this product to power receptacle. Attention-ne pas utiliser de rallonge pour raccorder le detecteur-disjoncteur a la prise de courant.**
- **Replace cordset only with HP 8120 series. Attention - Remplacer uniquement par un cordon amovible numero 8120.**
- **Do not use in wet location. Ne pas utiliser dans un emplacement mouille.**

---

**WARNING**

**Whenever it is likely that the protection has been impaired, the instrument must be made inoperative and be secured against any unintended operation.**

**If this instrument is to be energized via an autotransformer (for voltage reduction), make sure the common terminal is connected to the earth terminal of the power source.**

**If this product is not used as specified, the protection provided by the equipment could be impaired. This product must be used in a normal condition (in which all means for protection are intact) only.**

**No operator serviceable parts in this product. Refer servicing to qualified personnel. To prevent electrical shock, do not remove covers.**

**Servicing instructions are for use by qualified personnel only. To avoid electrical shock, do not perform any servicing unless you are qualified to do so.**

**The opening of covers or removal of parts is likely to expose dangerous voltages. Disconnect the product from all voltage sources while it is being opened.**

**Adjustments described in the manual are performed with power supplied to the instrument while protective covers are removed. Energy available at many points may, if contacted, result in personal injury.**

**The power cord is connected to internal capacitors that may remain live for 5 seconds after disconnecting the plug from its power supply.**

**For Continued protection against fire hazard, replace the line fuse(s) only with 250 V fuse(s) or the same current rating and type (for example, normal blow or time delay). Do not use repaired fuses or short circuited fuseholders. FUSE: T 5.0A**

---

**CAUTION**

Always use the three-prong ac power cord supplied with this product. Failure to ensure adequate earth grounding by not using this cord may cause personal injury and/or product damage.

This product is designed for use in Installation Category II and Pollution Degree 2 per IEC 1010 and IEC 664 respectively. For indoor use only.

This product has autoranging line voltage input, be sure the supply voltage is within the specified range.

Ventilation Requirements: When installing the product in a cabinet, the convection into and out of the product must not be restricted. The ambient temperature (outside the cabinet) must be less than the maximum operating temperature of the product by 4° C for every 100 watts dissipated in the cabinet. If the total power dissipated in the cabinet is greater than 800 watts, then forced convection must be used.

---

To prevent electrical shock, disconnect instrument from mains (line) before cleaning. Use a dry cloth or one slightly dampened with water to clean the external case parts. Do not attempt to clean internally.

### **Product Markings**

CE - the CE mark is a registered trademark of the European Community. A CE mark accompanied by a year indicated the year the design was proven.

CSA - the CSA mark is a registered trademark of the Canadian Standards Association.

### **CERTIFICATION**

Hewlett-Packard Company certifies that this product met its published specifications at the time of shipment from the factory.

Hewlett-Packard further certifies that its calibration measurements are traceable to the United States National Institute of Standards and Technology, to the extent allowed by the Institute's calibration facility, and to the calibration facilities of other International Standards Organization members.

## Hewlett-Packard Warranty Statement for Commercial Products

HP 8935 Series E6380A CDMA Cellular/PCS Base Station Test Set

### Duration of Warranty: 1 year

1. HP warrants HP hardware, accessories and supplies against defects in materials and workmanship for the period specified above. If HP receives notice of such defects during the warranty period, HP will, at its option, either repair or replace products which prove to be defective. Replacement products may be either new or like-new.
2. HP warrants that HP software will not fail to execute its programming instructions, for the period specified above, due to defects in material and workmanship when properly installed and used. If HP receives notice of such defects during the warranty period, HP will replace software media which does not execute its programming instructions due to such defects.
3. HP does not warrant that the operation of HP products will be uninterrupted or error free. If HP is unable, within a reasonable time, to repair or replace any product to a condition as warranted, customer will be entitled to a refund of the purchase price upon prompt return of the product.
4. HP products may contain remanufactured parts equivalent to new in performance or may have been subject to incidental use.
5. The warranty period begins on the date of delivery or on the date of installation if installed by HP. If customer schedules or delays HP installation more than 30 days after delivery, warranty begins on the 31st day from delivery.
6. Warranty does not apply to defects resulting from (a) improper or inadequate maintenance or calibration, (b) software, interfacing, parts or supplies not supplied by HP, (c) unauthorized modification or misuse, (d) operation outside of the published environmental specifications for the product, or (e) improper site preparation or maintenance.
7. TO THE EXTENT ALLOWED BY LOCAL LAW, THE ABOVE WARRANTIES ARE EXCLUSIVE AND NO OTHER WARRANTY OR CONDITION, WHETHER WRITTEN OR ORAL IS EXPRESSED OR IMPLIED AND HP SPECIFICALLY DISCLAIMS ANY IMPLIED WARRANTIES OR CONDITIONS OR MERCHANTABILITY, SATISFACTORY QUALITY, AND FITNESS FOR A PARTICULAR PURPOSE.

8. HP will be liable for damage to tangible property per incident up to the greater of \$300,000 or the actual amount paid for the product that is the subject of the claim, and for damages for bodily injury or death, to the extent that all such damages are determined by a court of competent jurisdiction to have been directly caused by a defective HP product.
9. TO THE EXTENT ALLOWED BY LOCAL LAW, THE REMEDIES IN THIS WARRANTY STATEMENT ARE CUSTOMER'S SOLE AND EXCLUSIVE REMEDIES. EXCEPT AS INDICATED ABOVE, IN NO EVENT WILL HP OR ITS SUPPLIERS BE LIABLE FOR LOSS OF DATA OR FOR DIRECT, SPECIAL, INCIDENTAL, CONSEQUENTIAL (INCLUDING LOST PROFIT OR DATA), OR OTHER DAMAGE, WHETHER BASED IN CONTRACT, TORT, OR OTHERWISE.

FOR CONSUMER TRANSACTIONS IN AUSTRALIA AND NEW ZEALAND: THE WARRANTY TERMS CONTAINED IN THIS STATEMENT, EXCEPT TO THE EXTENT LAWFULLY PERMITTED, DO NOT EXCLUDE RESTRICT OR MODIFY AND ARE IN ADDITION TO THE MANDATORY STATUTORY RIGHTS APPLICABLE TO THE SALE OF THIS PRODUCT TO YOU.

## ASSISTANCE

### **Maintenance Agreements**

Product maintenance agreements and other customer assistance agreements are available for Hewlett-Packard products. For any assistance, contact your nearest Hewlett-Packard Sales and Service Office.

# Regional Sales Offices

**IMPORTANT**

## Regional Sales and Service Offices

<p>Eastern USA Sales Office Hewlett-Packard Company 2101 Gather Rd. Rockville, MD 20850 Tel: (301) 258-2000</p>	<p>Eastern USA Sales Office Hewlett-Packard Company 2101 Gather Rd. Rockville, MD 20850 Tel: (301) 258-2000</p>	<p>Midwestern USA Sales and Service Hewlett-Packard Company 5201 Tollview Drive Rolling Meadows, IL 60008 Tel: (708) 342-2000</p>
<p>Southern USA Sales and Service Hewlett-Packard Company 1995 North Park Place Atlanta, GA 30339 Sales Tel: (404) 955-1500 Fax: (404) 980-7292 Service Tel: (404) 850-2544 Fax: (404) 980-7292</p>	<p>Southern USA Service Center Hewlett-Packard Company 930 E. Campbell Road Richardson, TX 75081 Tel: (214) 699-4331</p>	<p>Western USA Service Center Hewlett-Packard Company 301 E. Evelyn Avenue Mountain View, CA 94041 Tel: (415) 694-2000 Fax: (415) 694-0601</p>
<p>Western USA Sales and Service Hewlett-Packard Company 24 Inverness Place East Englewood, CO 80112 Sales Tel: (303) 649-5000 Fax: (303) 649-5787 Service Tel: (303) 649-5512 Fax: (303) 649-5787</p>	<p>Western USA Sales and Service Hewlett-Packard Company 1421 South Manhattan Avenue Fullerton, CA 92631 Sales Tel: (714) 999-6700 Fax: (714) 778-3033 Service Tel: (714) 758-5490 Fax: (714) 778-3033</p>	<p>United States of America Customer Information Center Hewlett-Packard Company Tel: (800) 752-0900 6:00 am to 5:00 pm Pacific Time Parts Direct: 1-800-227-8164</p>
<p>South Eastern Europe Sales and Service Hewlett-Packard Ges. m.b.h. Liebigasse 1 P.O. Box 72 A-1222 Vienna, Austria Telephone: 43 222 2500 0 Telex: 13 4425</p>	<p>European Multicountry Region Sales and Service Hewlett-Packard S.A. P.O. Box 95 150, Route dv Nant_dl AVRIL CH-1217 Meyrin 2 Geneva, Switzerland Telephone: (41/22) 780-8111 Fax: (41/22) 780-8542</p>	<p>Northern Europe Sales and Service Hewlett-Packard Nederland B.V. Startbaan 16 1187 XR Amstelveen, The Netherlands P.O. Box 667 Telephone: 31/20 5476911 X 6631 Fax: 31-20-6471825NL</p>

<p>Asia Sales and Service Hewlett-Packard Asia Ltd. 22-30/F Peregrine Tower Lippo Center 89 Queensway, Central Hong Kong G.P.O. Box 863 Hong Kong Telephone: 852-848-7777 Fax: 852-868-4997</p>	<p>Japan Sales and Service Yokogawa-Hewlett-Packard Ltd. 3-29-21, Takaido-Higashi Suginami-Ku, Tokyo 168 Telephone: 81 3 3331-6111 Fax: 81 3 3331-6631</p>	<p>International Sales Branch Headquarters Sales and Service Hewlett-Packard S.A. 39 Rue Veyrot P.O. Box 365 1217 Meyrin 1 Geneva, Switzerland Telephone: 41-22-780-4111 Fax: 41-22-780-4770</p>
<p>Australia, New Zealand Sales and Service Hewlett-Packard Ltd. P.O. Box 221 31-41 Joseph Street Blackburn, Victoria 3130 Telephone: (61/3) 895-2895 Fax: (61/3) 898-9257</p>	<p>Canada Sales and Service Hewlett-Packard (Canada) Ltd. 5150 Spectrum Way Mississauga, Ontario L4W 5G1 Canada Telephone: (416) 206-4725 Fax: (416) 206-4739</p>	<p>Canada Service Center Hewlett-Packard Company 17500 Transcanada Highway S. Serv Road Kirkland, Quebec H9J 2X8 Canada Telephone: (416) 206-3295</p>
<p>Canada Service Center Hewlett-Packard Ltd. 11120 178 Street Edmonton, Alberta T5S 1P2 Canada Telephone: (403) 486-6666 Fax: (403) 489-8764</p>	<p>Latin America Hewlett-Packard Company LAHQ Mexico City Col. Lomas de Virreyes 11000 Mexico D.F. Mexico Telephone: (52/5) 326-4000 Fax: (52/5) 202 7718</p>	<p>United Kingdom Sales and Service Hewlett-Packard Ltd. Cain Road Amen Corner Bracknell, Berkshire RG12 1HN United Kingdom Telephone: 44 344 360000</p>

In This Manual





---

# 1 Getting Started with AMPS Test

This chapter introduces you to the HP 8935 Series E6380A CDMA Cellular/PCS Base Station Test Set and its AMPS functions. For information on other functions in the Test Set, see [“Which Document is Required?” on page 18](#). To proceed immediately to the test procedures, see [“AMPS Tests You Can Perform” on page 30](#).

## About the Test Set

### Product Description

This Test Set helps you install, commission, and maintain AMPS base stations. It also allows you to test CDMA base stations. (This guide discusses AMPS testing. For more information about CDMA testing, refer to the *CDMA Base Station Tests Applications Guide*.)

The Test Set contains an RF signal generator, RF analyzer, AF analyzer, and AF generator to test AMPS base stations. The following tools are also included:

Code Domain Analyzer

CDMA Analyzer

CDMA Generator

Spectrum Analyzer

Power Meter

Oscilloscope

AC/DC Voltmeter

IBASIC controller

### Batteries

There are two methods the Test Set uses to back up its RAM. One is a set of two AA batteries mounted inside the rear panel of the Test Set. You must periodically change these batteries. The second method of RAM backup is an internal battery. It is not user serviceable.

Failure to take prompt action may result in loss of RAM data including IBASIC programs and SAVE/RECALL states stored in the RAM.

To change the AA batteries, use the following procedure:

1. Turn off power and unplug the Test Set.
2. Remove the six screws in the rear panel using a TX-15 TORX<sup>(R)</sup> screwdriver.
3. Remove the rear cover.
4. Replace the AA batteries. Do not use rechargeable batteries.
5. Replace the rear panel.

## Getting Help

If you have problems using this Test Set, and cannot find the solution in these documents or the help screens, please use one of the following contacts:

Your local or regional sales office (see "[Regional Sales and Service Offices](#)" on page 12)

U.S. Call Center: 800 542-4844

Korea HP Direct: (82/2) 769-0800

Canada HP Direct: (800) 387-3154

European Call center: +31 20 547-9990

Test and Measurement Organization on the web:  
<http://www.tmo.hp.com/>

## What's Included with this Test Set

The equipment commonly shipped with the base Test Set is listed below. Options that you order with your Test Set may change this list.

### Test Set

#### Documentation:

- CDMA Applications Guide
- CD-ROM with the above listed manual, *AMPS Base Station Tests Applications Guide*, *Assembly Level Repair Manual*, *Programmer's Guide*, and *HP 8935 Series E6380A Reference Guide* in Adobe™ Acrobat Reader format (.pdf).

### Power cord

Cover for the front panel of the Test Set

---

## Manual and Automatic Operation Modes

You can operate the Test Set in either of two modes: manual or automatic. Controlling the Test Set with the keypad is manual operation. Controlling the Test Set with a program is automatic Operation.

Use manual mode when you want to control the Test Set with the front panel. Manual operation is described in this document.

Use automatic mode when you want to control the Test Set with its internal IBASIC controller. To use the Test Set in automatic mode, you must load an IBASIC program into the Test Set's memory.

### IBASIC programs

You can obtain an IBASIC program in two ways: either write it yourself, or purchase a software package from Hewlett-Packard. To write programs yourself, refer to the *Programmer's Guide*, included with the Test Set's documentation.

Many of HP's software packages are manufacturer-specific packages. Manufacturer-specific software packages provide automated testing of the manufacturer's base station to greatly reduce test times and provide test setup repeatability. Once configured, the software typically controls both the base station and the Test Set and prompts the user to make the required connections during testing. Test results can be printed and/or saved to a file for later use. Contact your local HP Sales Office to find out which software packages are currently available.

## Maximizing the Accuracy of Your Measurements

This Test Set is designed to make highly accurate measurements. However, to ensure that you have the most accurate measurements available, you can perform the following tasks:

### Calibration

You should calibrate the Test Set whenever you change or add an internal assembly. You may want to calibrate when you upgrade firmware. See the *Assembly Level Repair Manual* for calibration procedures.

### TX Power Temperature Compensation

The Test Set is internally compensated. However, power measurement calibration can be optimized for temperature changes using the TX Pwr Zero field on the RF ANALYZER screen. The new calibration factors are stored in RAM until the next time the routine is used.

To have the Test Set zero the TX Power measurement automatically when needed, set the Auto Zero field on the RF ANALYZER screen to Auto. During operation, the Test Set will temporarily halt the TX Power measurement as it is calibrated. This can happen during a measurement. If interrupting the measurement is a problem for your test setup, set the Auto Zero field to Manual, and select TX Pwr Zero whenever you want to manually calibrate the measurement.

## Display an FM Carrier Signal (Loopback Test)

Since an AMPS base station is basically a continuous wave (CW) FM signal, this section will guide you through the process of generating and displaying an FM signal at a cellular band frequency. It is intended to make you feel more comfortable with using the Test Set. If you are ready to begin testing, proceed to Chapter 2.

### NOTE

In the following operating example, you enter a common frequency for the RF generator and RF analyzer to create and view the Test Set's own signal. However, typical AMPS base station testing uses channel assignments with different transmit and receive frequencies. This is explained further in ["Using Channel Numbers to Set Analyzer and Generator Frequencies"](#) on page 68.

## Connections for FM Carrier Loopback Test

Connect the Test Set as shown below.

**Figure 1-1** FM Carrier Loopback Test Connections

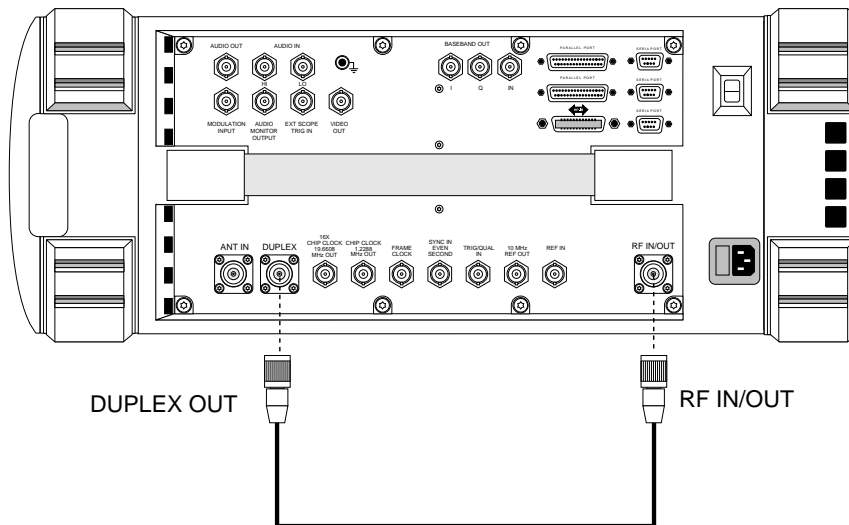

## Get Started with the Test Set

Here are some guides for selecting screens and fields:

Use the knob to move the cursor around the screen. Reverse video boxes indicate fields that can be selected.

To select a field on the screen, push the knob, or press the **Enter** key.

Use the **RF Gen**, **RF Anl**, and **Spec Anl** keys to access the RF GENERATOR, RF ANALYZER, and SPEC ANL screens.

Selecting the titlebar at the top of the screen displays a list of screens that can be immediately accessed when selected.

## Preparing the Test Set

1. Plug in the Test Set.
2. Turn on the Test Set (or press **Preset** if it is already on). The CDMA ANALYZER screen will be displayed.
3. Press the **Inst Config** key.
4. Select **RF Display**, and set the field to **Freq**.
5. Verify your connections. See [“Connections for FM Carrier Loopback Test” on page 23](#).

## Generate an FM Carrier Signal

Refer to [Figure 1-2](#).

1. Press **CDMA Gen** to go to the CDMA GENERATOR screen.
2. Select **CW RF Path** and set it to **Bypass**. This shuts off the IQ modulation normally used for CDMA testing.
3. Press the **RF Gen** key to go to the RF GENERATOR screen.
4. Select **RF Gen Freq** and use the keypad to set the frequency to **850.000 MHz**.
5. Select **Amplitude** and set the amplitude to **0 dBm**.
6. Select **Output Port** and verify that the port is set to **Dupl**.
7. Turn on FM modulation by positioning the cursor in the lower half of the **AFGen1 To** field and pressing the **on/off** key.

The default FM deviation is 2.9 kHz. The default FM rate is 1.0 kHz.



**NOTE** AF generators 1 and 2 are automatically turned off anytime you access any of the CDMA screens (CDMA GENERATOR, CDMA ANALYZER, CODE DOM). This prevents accidental addition of AM or FM when generating a CDMA signal. If you accidentally access any of the CDMA screens when testing an AMPS base station, any AM or FM you specified on the RF GENERATOR screen will be turned off while on that CDMA screen. Previously set AM and/or FM are automatically turned back on when returning to the RF GENERATOR screen.

**Figure 1-2 Setting Up the RF Generator**

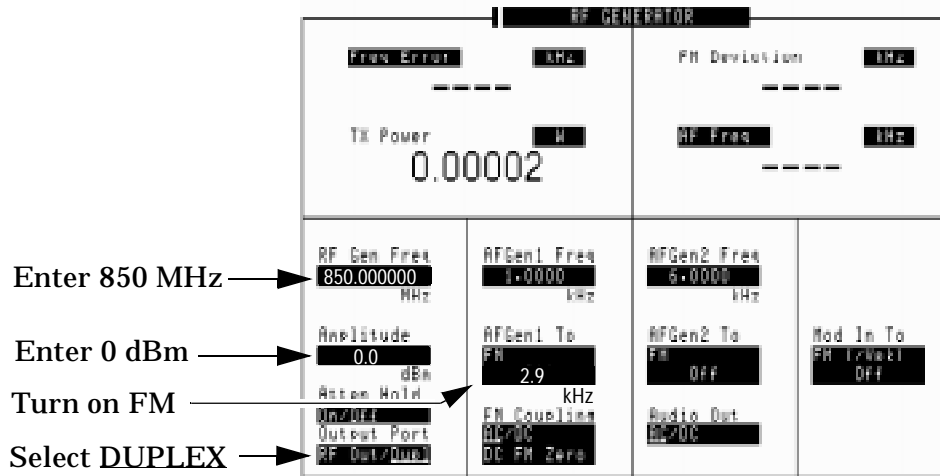

Chapter 1  
Getting Started with AMPS  
Test

## Analyzing an FM Carrier Signal

1. Press the **RF Anl** key to go to the RF ANALYZER screen.
2. Select **Tune Freq** and use the keypad to set the frequency to 850.000 MHz. Notice that the Frequency Error, TX Power, FM Deviation, and AF Frequency for the signal are automatically displayed.

**Figure 1-3** Default RF Analyzer Measurements

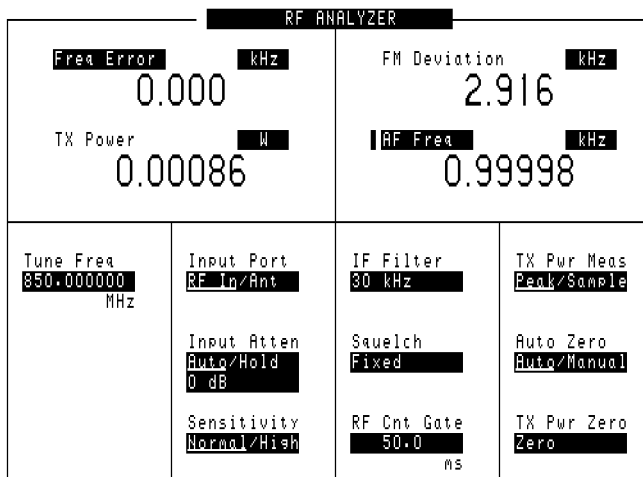

3. Press the **Spec Anl** key to go to the SPECTRUM ANALYZER screen.
4. The signal is displayed.
5. Select **Span** and set it to 30.000 kHz to get a good view of the modulated signal. See [Figure 1-4](#).

**Figure 1-4** FM Carrier Signal

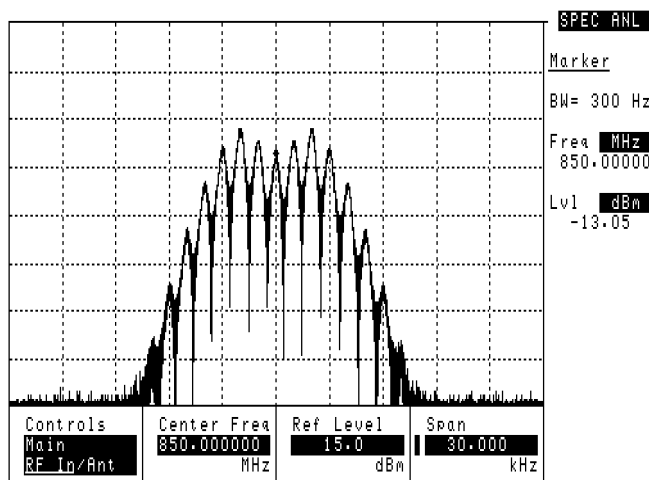

## What to Do Next

Congratulations! You are now ready to begin testing your AMPS Base Station. Proceed to [Chapter 2, “Testing AMPS Base Stations,”](#) on page [29](#).



---

## 2

# Testing AMPS Base Stations

Advanced Mobile Phone System (AMPS) base stations for cellular telephone systems are basically continuous wave (CW) FM voice transceivers with some control and data signals for system operation. This chapter explains how to use the Test Set to manually test the RF and AF performance of the transmitter and receiver portions of the base station.

## AMPS Tests You Can Perform

The following tests are explained in this manual:

- "Transmitter Frequency Error/Offset and Power Test" on page 34.
- "Transmitter SAT Frequency and Deviation" on page 36.
- "Transmitter Data Deviation" on page 38.
- "Transmitter Maximum Voice Deviation" on page 40.
- "Receiver Sensitivity (SINAD)" on page 42.
- "Receiver Squelch Threshold" on page 45.

---

### CAUTION

Transmitter power (TX Power) can only be measured through the Test Set's RF IN/OUT port. Verify that the signal connected to this port does not exceed the limits printed by the port.

If you hear a loud "warbling" sound from the Test Set, turn off your transmitter immediately! This is the over-power alarm, warning that instrument damage may occur. *Caution:* Turning the Test Set off at this point does not protect the internal circuitry. Also, removing the cable from the RF IN/OUT port without turning the transmitter off may damage your transmitter or power amplifier (due to an impedance mismatch).

The ANT IN port is only used for analyzing very low level signals ( $\leq 60$  mW). Never attempt to measure a transmitter's power directly using the ANT IN port, as instrument damage may occur.

The DUPLEX OUT port is only used to provide RF signals to the base station's receive port(s). It must not be connected to the base stations transmit port or damage may occur to the Test Set.

---

## What You Need to Know to Begin

You need to know how to control the base station and the basic operation of the Test Set before you can test your base station.

Test Set operation includes how to change control settings, how to navigate between control screens, and how to change the units used for any measurement or setting. Test Set operation and feature descriptions are included in the *Reference Guide*.

Base station operation includes turning the transmitter on and off, turning the SAT tone and data signals on and off, and knowing where to connect test cables from the Test Set to your base station.

You also need to properly configure the Test Set for your test situation. The following sections describe operations needed to simplify Test Set operation and minimize measurement errors.

- Entering the known losses and/or gains in your test setup is explained in "[Compensating for Signal Losses and Gains in the Test Setup](#)" on page 33.
- Measuring the signal loss through cables and other devices is explained in "[Measuring Insertion Losses](#)" on page 51.
- Choosing to enter your base station's transmit and receive frequencies by channel number or by discrete frequencies is explained in "[Using Channel Numbers to Set Analyzer and Generator Frequencies](#)" on page 68.

## Connecting the Test Set to Your Base Station

The connections shown in [Figure 2-1](#) indicate a “generic” base station using a test interface for audio test signals and a laptop computer running a control program to control the base station. A power splitter is used for testing the receiver ports. Although this is a common setup for performing tests, audio and RF connections to base stations and the ways base stations are controlled vary among manufacturers.

**Figure 2-1** Connections Between the Test Set and the Base Station

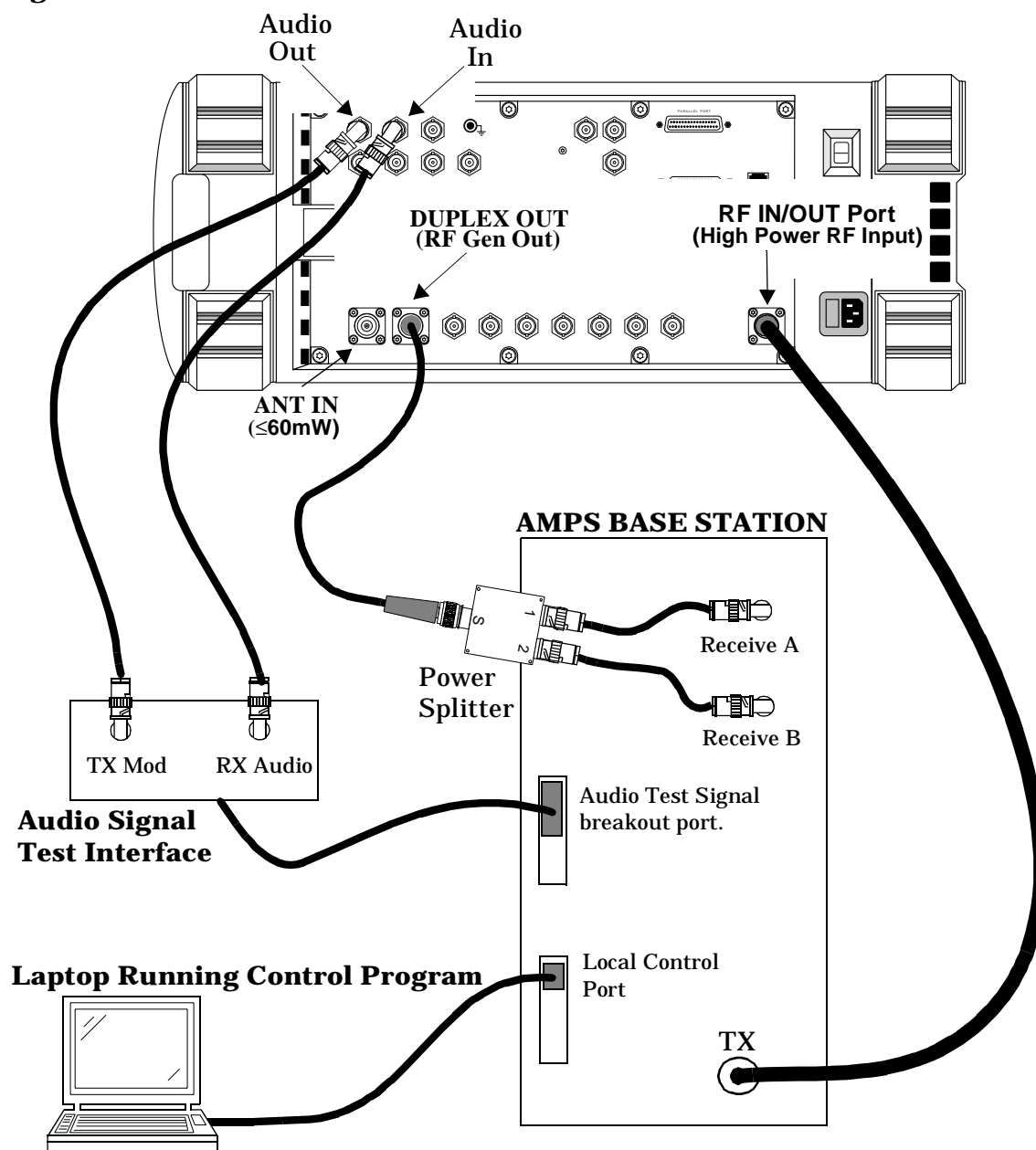



## Compensating for Signal Losses and Gains in the Test Setup

Signal losses or gains through cables, splitters, combiners, connectors, amplifiers, or coaxial switches must be accounted for to ensure measurement accuracy. These values are entered in the INSTRUMENT CONFIGURE screen (press the **Inst Config** key).

Refer to "[Measuring Insertion Losses](#)" on page 51 for information about measuring cable/system losses.

- Total losses/gains between the transmitter's output and the Test Set's RF IN/OUT port are entered in the RF In/Out field. A negative number (indicating a loss) causes the displayed TX power measurement to be increased by the entered amount. A positive number (indicating a gain) causes the RF analyzer to decrease the displayed TX power measurement by the entered amount.
- Total losses between the Test Set's DUPLEX OUT port and the base station's receive port(s) are entered in the Duplex Out field as a negative number (such as  $-1.2$ ). The RF Generator will automatically increase its level out of the DUPLEX OUT port by the value entered to compensate for the loss.

**Figure 2-2** Entering Test System Losses and Gains

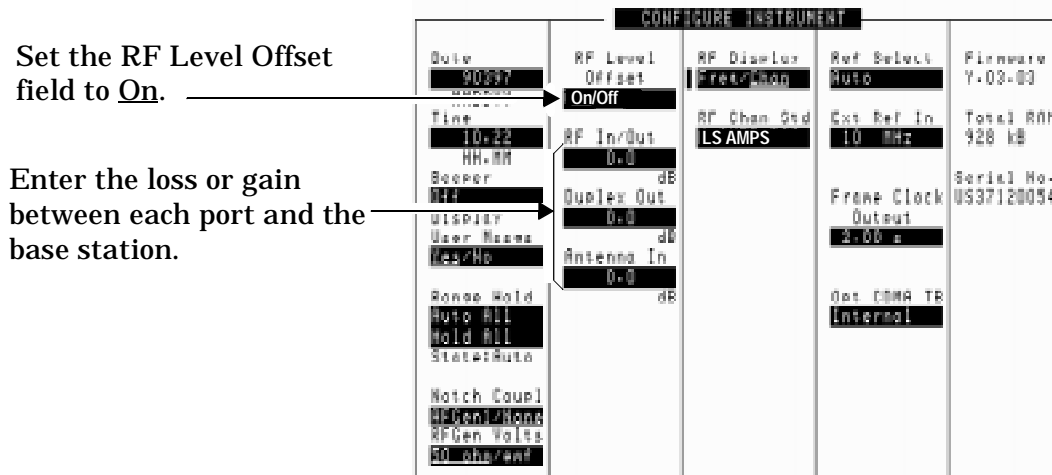

## Transmitter Frequency Error/Offset and Power Test

This test compares the measured center frequency of the base station to the AMPS channel standard. The resulting difference is the frequency error (also called the frequency offset). The measurement can be displayed in frequency units (Hz, kHz, MHz) or in parts per million (ppm). Measurements are made with all modulation turned off.

The transmitter's power can be measured any time the transmitter is keyed, but may not be accurate unless all modulation is turned off. Transmitter power may be specified by the manufacturer in units of watts (W), milliwatts (mW), dBm, Volts (V), or millivolts (mV).

### Prerequisites

The following conditions must be met before testing:

- The Test Set is turned on *and Preset was pressed to establish a known instrument state.*
- You have configured the Test Set for channel or frequency tuning as necessary (see **“Using Channel Numbers to Set Analyzer and Generator Frequencies” on page 68**).
- You have specified any gains or losses in your test system (see **“Compensating for Signal Losses and Gains in the Test Setup” on page 33**).

### Begin Testing

1. *Turn off the base station's RF transmitter.* A transmitter can be damaged if it is not transmitting into a specified load, such as an antenna, power amplifier, duplexer, or power meter with a 50 $\Omega$  input impedance.
2. Verify that the transmitter's rated RF power (or the level out of the power amplifier if applicable) does not exceed the level printed next to the Test Set's RF IN/OUT connector.
3. Connect the transmitter's RF output to the Test Set's RF IN/OUT port.
4. Turn off any modulation signals to the base station.
  - Turn off the SAT tone.
  - Turn off any data (digital) modulation signals.
  - Turn off any audio (voice) modulation signals.
5. Press the RF Anl key to access the RF ANALYZER screen.
6. Enter the transmitter's RF Channel number.

- Turn on the transmitter. The TX Freq Error and TX Power measurements are displayed.

Note: Disregard any values shown for FM Deviation and AF Freq at this time.

**Figure 2-3 Transmitter Frequency Error and Power Test Results**

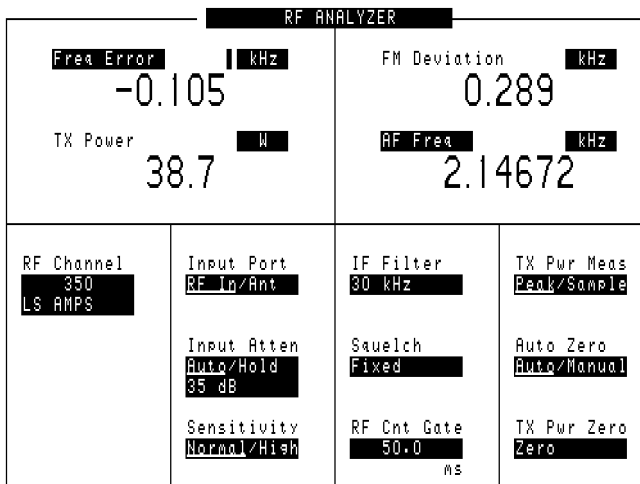

## Transmitter SAT Frequency and Deviation

This test measures the transmitter's Supervisory Audio Tone (SAT) frequency and deviation in the absence of any other modulating signal.

### Prerequisites

The following conditions must be met before testing:

- The Test Set is turned on *and Preset was pressed to establish a known instrument state.*
- You have configured the Test Set for channel tuning (see **“Using Channel Numbers to Set Analyzer and Generator Frequencies” on page 68**).
- You have specified any gains or losses in your test system (see **“Compensating for Signal Losses and Gains in the Test Setup” on page 33**).

### Test Procedure

1. *Turn off the base station's RF transmitter.* A transmitter can be damaged if it is not transmitting into a specified load, such as an antenna, power amplifier, duplexer, or power meter with a 50 $\Omega$  input impedance.
2. Verify that the transmitter's rated RF power (or the level out of the power amplifier if applicable) does not exceed the level printed next to the Test Set's RF IN/OUT connector.
3. Connect the transmitter's RF output to the Test Set's RF IN/OUT port.
4. Turn off the voice modulation to the transmitter.
5. Turn off data modulation to the transmitter.
6. Enable SAT transmission.
7. Press **Shift, RF Anl (AF Anl)** to access the AF ANALYZER screen.

- Set the Filter 2 field to 6 kHz BPF. This helps remove unwanted noise.

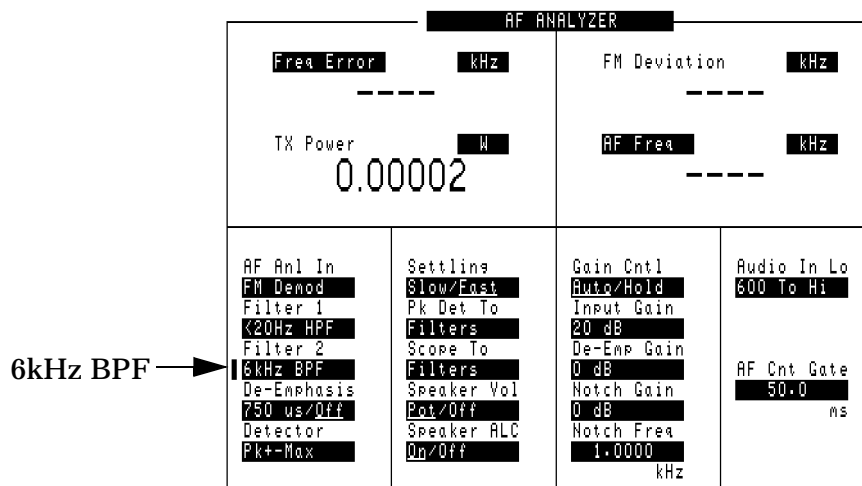

- Press the RF Anl key to access the RF ANALYZER screen.
- Enter the transmitter's channel number in the RF Channel field.
- Turn on the transmitter. The FM Deviation and AF Freq for the SAT are displayed (as well as Frequency Error and TX Power).

**Figure 2-4 SAT Frequency and Deviation Test Results**

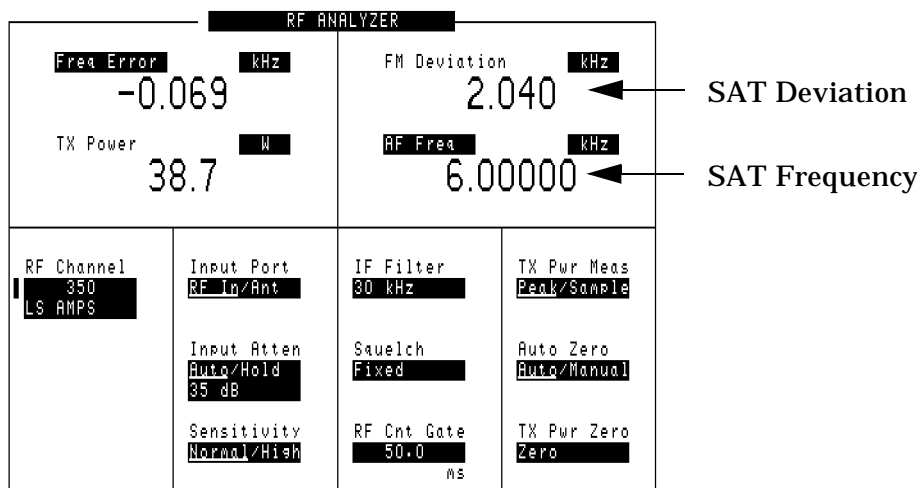

## Transmitter Data Deviation

This test measures the transmitter's digital data deviation in the absence of any other modulating signal.

### Prerequisites

The following conditions must be met before testing:

- The Test Set is turned on *and Preset was pressed to establish a known instrument state.*
- You have configured the Test Set for channel tuning (see **“Using Channel Numbers to Set Analyzer and Generator Frequencies” on page 68**).
- You have specified any gains or losses in your test system (see **“Compensating for Signal Losses and Gains in the Test Setup” on page 33**).

### Test Procedure

1. *Turn off the base station's RF transmitter.* A transmitter can be damaged if it is not transmitting into a specified load, such as an antenna, power amplifier, duplexer, or power meter with a 50 $\Omega$  input impedance.
2. Verify that the transmitter's rated RF power (or the level out of the power amplifier if applicable) does not exceed the level indicated next to the Test Set's RF IN/OUT connector.
3. Connect the transmitter's RF output to the Test Set's RF IN/OUT connector.
4. Turn off voice modulation to the transmitter.
5. Turn off the SAT to the transmitter.
6. Turn on the data modulation to the transmitter.
7. Press **Shift, RF Anl (AF Anl)** to access the AF ANALYZER screen.

8. Set Filter 1 to <20Hz HPF.
9. Set Filter 2 to >99kHz LP.

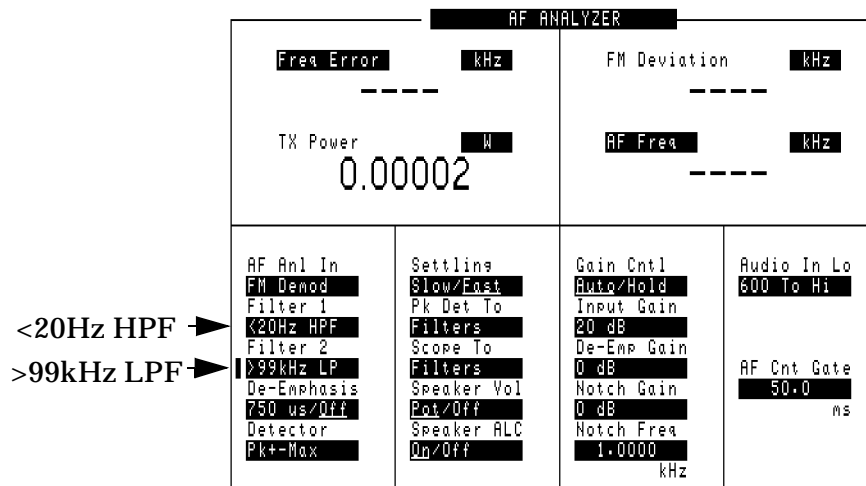

10. Press the RF Anl key to access the RF ANALYZER screen.
11. Enter the transmitter's channel number in the RF Channel field.
12. Turn on the transmitter. The FM Deviation from the data is displayed.

**Figure 2-5 Data Deviation Test Results**

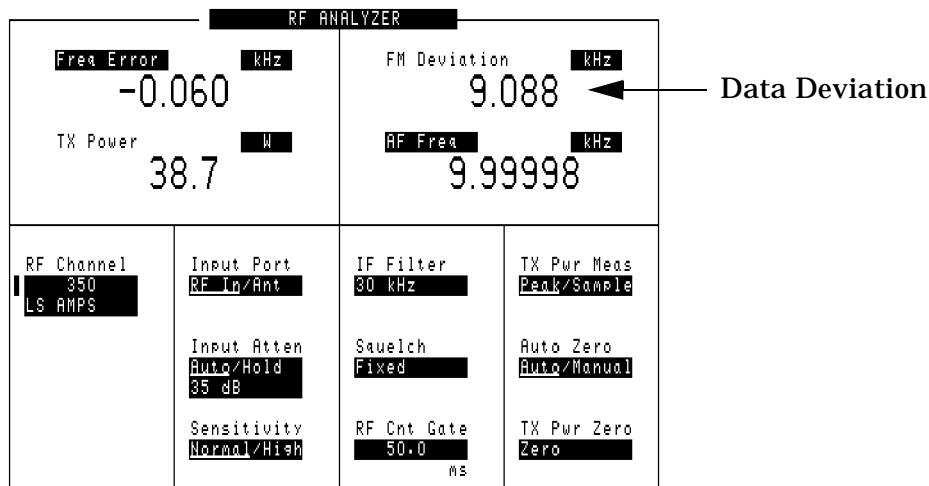

## Transmitter Maximum Voice Deviation

This test measures the transmitter's maximum FM Deviation by a voice signal in the absence of any other modulation signal.

### Prerequisites

The following conditions must be met before testing:

- The Test Set is turned on *and Preset was pressed to establish a known instrument state.*
- You have configured the Test Set for channel tuning (see **“Using Channel Numbers to Set Analyzer and Generator Frequencies” on page 68**).
- You have specified any gains or losses in your test system (see **“Compensating for Signal Losses and Gains in the Test Setup” on page 33**).

### Test Procedure

1. *Turn off the base station's RF transmitter.* A transmitter can be damaged if it is not transmitting into a specified load, such as an antenna, power amplifier, duplexer, or power meter with a 50 $\Omega$  input impedance.
2. Verify that the transmitter's rated RF power (or the level out of the power amplifier if applicable) does not exceed the level indicated next to the Test Set's RF IN/OUT connector.
3. Connect the transmitter's RF output to the Test Set's RF IN/OUT port.
4. Connect the transmitter's audio modulation (voice) input to the Test Set's AUDIO OUT port.
5. Enable the transmitter's audio (speech) modulation.
6. Turn off any modulation signals to the base station other than audio.
7. Press the RF Anl key to access the RF ANALYZER screen.
8. Enter the transmitter's channel number in the RF Channel field.



9. Press the RF Gen key to access the RF GENERATOR screen.
10. Set the AFGen1 To field to Audio Out, and a level of 50 mV.

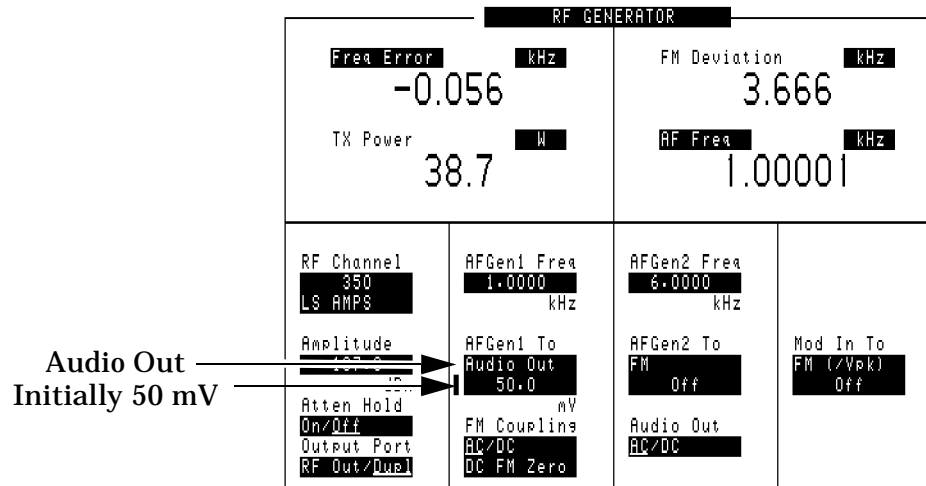

11. With the cursor still positioned in front of the level setting (50 mV), press the Incr Set key and enter 20 dB using the keypad.
12. Turn on the transmitter.
13. With the cursor still positioned in front of the level setting (50 mV) press the up-arrow key once to increment the level by 20 dB.
14. Read the FM deviation.
15. Vary the AFGen1 Freq from 300 Hz to 3 kHz and observe the FM deviation at each frequency. Deviation must not exceed the rated system specification of  $\pm 12$  kHz at any time.

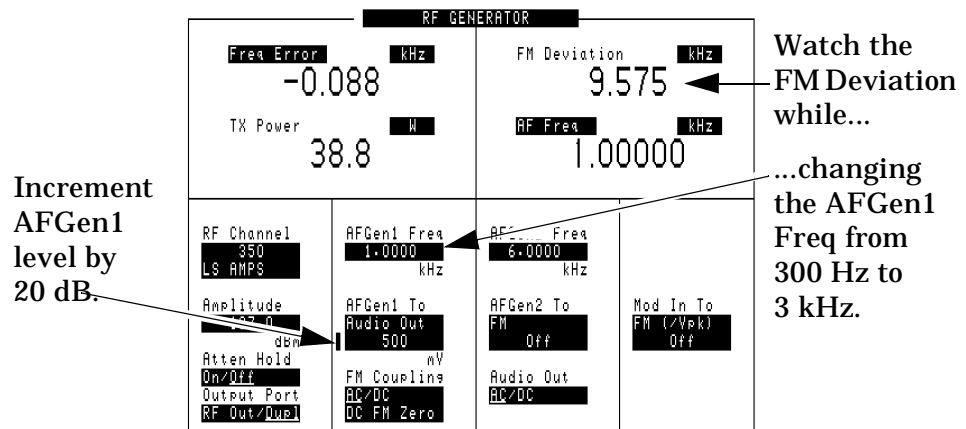

16. Disconnect the cable to the transmitter's audio modulation input (connected in step 4) to reduce the chance of errors in your next transmitter test.

## Receiver Sensitivity (SINAD)

This test measures the receiver's ability to demodulate voice signals from very low RF carrier levels.

### Prerequisites

The following conditions must be met before testing:

- The Test Set is turned on *and Preset was pressed to establish a known instrument state.*
- You have configured the Test Set for channel tuning (see **“Using Channel Numbers to Set Analyzer and Generator Frequencies” on page 68**).
- You have specified any gains or losses in your test system (see **“Compensating for Signal Losses and Gains in the Test Setup” on page 33**).

### Test Procedure

1. Turn off the base station's transmitter.
2. Turn the base station's radio squelch, data, and SAT off.
3. Connect the base station receiver's inputs to the Test Set's DUPLEX OUT port.
4. Connect the receiver's audio output to the Test Set's AUDIO IN port(s). Unless the receiver's audio out amplifier is not referenced to chassis ground, you should only connect to the AUDIO IN - HI port. For floating output amplifiers, see the *HP 8935 Series E6380A Reference Manual* for information on using the AUDIO IN - LO connection.
5. Press **CDMA Gen** to access the CDMA GENERATOR screen.

- Set the CW RF Path field to Bypass. This turns off the IQ modulation used for CDMA tests.

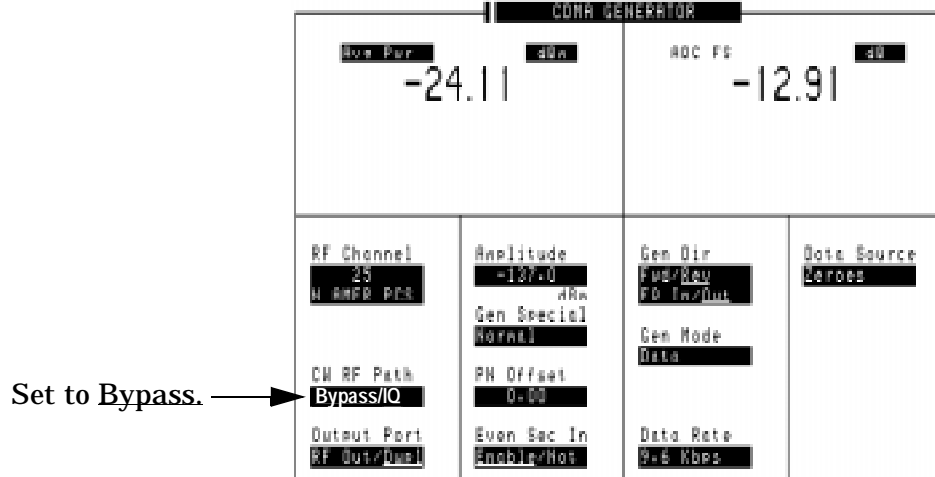

- Press **SHIFT, RFAIn** (AF An1) to access the AF ANALYZER screen.
- Set the AF An1 In field to Audio In.
- Set the Filter 1 field to C Message.

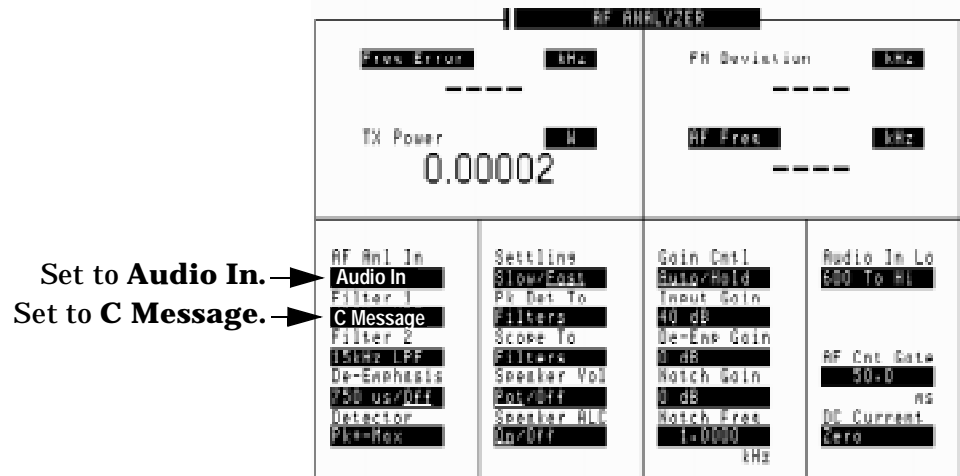

- Press the **RF Gen** key to access the RF GENERATOR screen.
- Change the lower audio measurement to SINAD. This is done by selecting the existing measurement and choosing SINAD from a list of choices.
- Set the AFGen1 To field to FM and turn it on (2.9 kHz) using the **On/Off** key.
- Enter the transmitter's channel number in the **RF Channel** field.

- Set an initial RF generator level in the Amplitude field. This value depends on the sensitivity of the receiver; but  $-90$  dBm should be a good starting point. At this point you should be able to turn the Test Set's Volume knob clockwise and hear a 1 kHz tone from the Test Set's speaker.

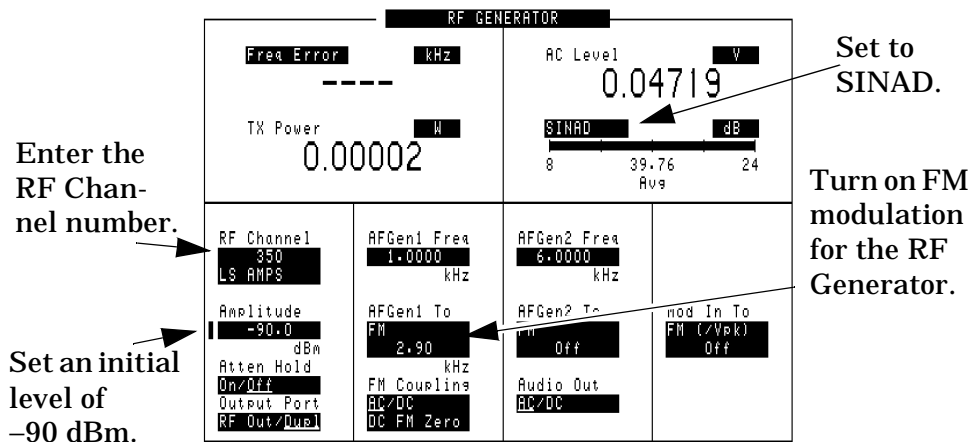

- Set the Amplitude field to increment in 1 dB units. To do this, position the cursor in front of the Amplitude field, press the Incr Set key, and enter 1 dB using the keypad.
- With the cursor front of the field, turn the knob to decrease the Amplitude setting until the desired SINAD measurement is displayed (commonly 12 dB). You should hear the 1 kHz tone get noisy as you approach the 12 dB SINAD reading.

**Figure 2-6 SINAD Test Results**

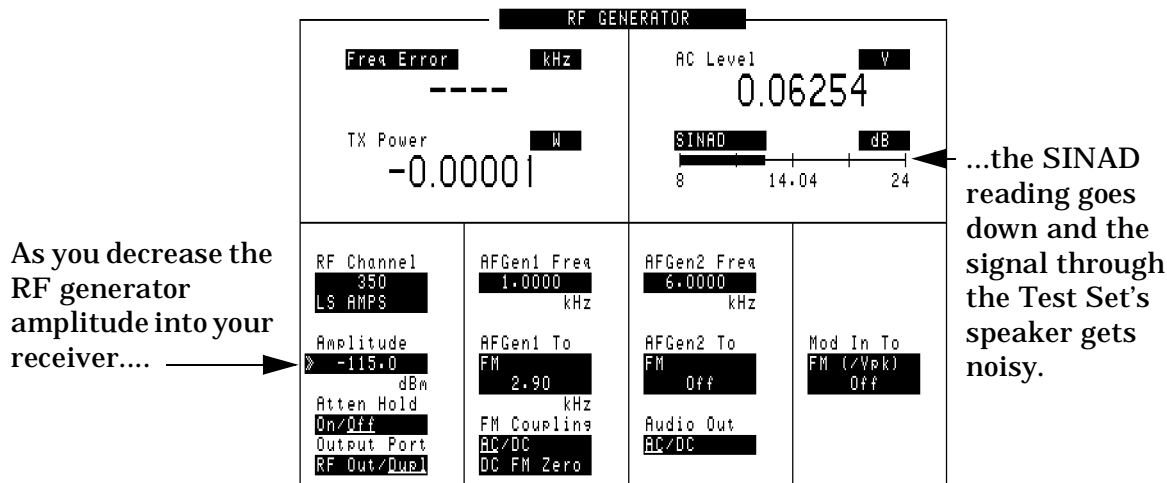

---

## Receiver Squelch Threshold

This test determines the RF Signal level where the receiver squelches (switches off) the audio output.

### Prerequisites

The following conditions must be met before testing:

- The Test Set is turned on and PRESET was pressed to establish a known instrument state.*
- You have pressed the **Preset** key to establish a known instrument state.
- You have configured the Test Set for channel tuning ([see “Using Channel Numbers to Set Analyzer and Generator Frequencies” on page 68](#)).
- You have specified any gains or losses in your test system ([see “Compensating for Signal Losses and Gains in the Test Setup” on page 33](#)).

### Test Procedure

1. Turn off the base station’s transmitter.
2. Turn the base station’s data and SAT off.
3. Connect the base station receiver’s inputs to the Test Set’s DUPLEX OUT port.
4. Connect the receiver’s audio output to the Test Set’s AUDIO IN port(s). Unless the receiver’s audio out amplifier is not referenced to chassis ground, you should only connect to the AUDIO IN - HI port. For floating output amplifiers, see the *HP 8935 Series E6380A Reference Manual* for information on using the AUDIO IN - LO connection.
5. Press **CDMA Gen** to access the CDMA GENERATOR screen.

6. Set the CW RF Path field to Bypass. This turns off the IQ modulation used for CDMA tests.

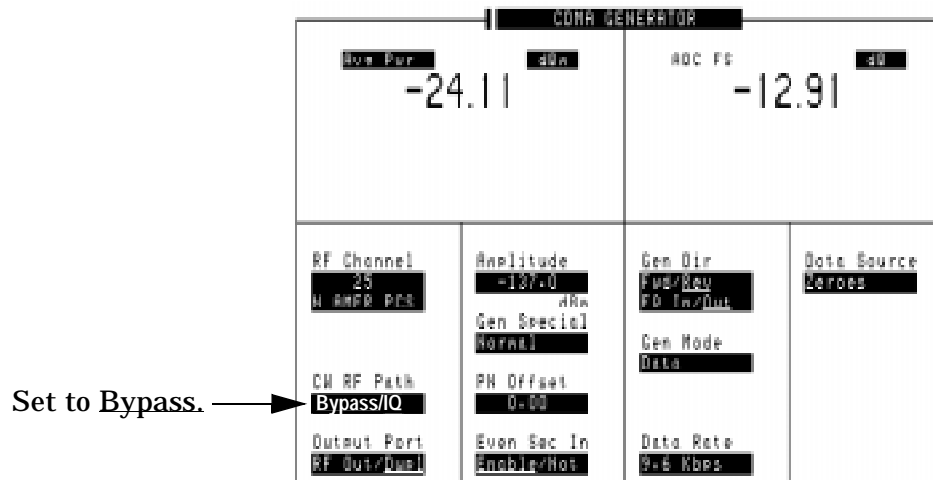

7. Press **SHIFT**, **RFAn1** (**AF An1**) to access the **AF ANALYZER** screen.
8. Set the **AF An1 In** field to **Audio In**.
9. Press the **RF Gen** key to access the **RF GENERATOR** screen.
10. Set the **AFGen1 To** field to **FM** and set it to **8 kHz** deviation.
11. Enter the transmitter's channel number in the **RF Channel** field.
12. Set the **Atten Hold** field to **On**. This prevents the Test Set from changing its internal attenuators during the test to prevent erroneous squelch interruption.

13. Set an initial RF generator level in the **Amplitude** field. This value depends on the sensitivity of the receiver; but **-90 dBm** should be a good starting point. At this point you should be able to turn the Test Set's Volume knob clockwise and hear a 1 kHz tone from the Test Set's speaker.

Enter the RF channel number.

Set a initial level of -90 dBm.

Set to On.

Turn on FM modulation for the RF generator and set to 8 kHz.

14. Set the **Amplitude** field to increment in 1 dB units. To do this, position the cursor in front of the **Amplitude** field, press the **incr set** key, and enter 1 dB using the keypad.
15. With the cursor in front of the **Amplitude** field, turn the knob counterclockwise to decrease the **Amplitude** setting until the received audio is no longer heard on the Test Set's speaker (or until the **AC Level** reading drops suddenly). The RF amplitude at which the audio signal is no longer output is the squelch threshold.





---

## **3 Utility Procedures**

This chapter contains procedures and instructions that will help you make the most efficient use of your Test Set.

## Beeper

The beeper notifies you when a message is displayed. Since a message may be removed from the screen before you notice it, it is better to leave the beeper on to alert you to errors during operation.

The beeper's volume setting is retained when the instrument is turned off.

## Beeper Control

1. Press the **Inst Config** key to go to the **INSTRUMENT CONFIGURE** screen.
2. Select **Beeper**.
3. Choose from **Off**, **Quiet**, or **Loud**.

# Measuring Insertion Losses

To make accurate power and receiver measurements, the signal loss through the cables or other devices used in your test setup must be known and entered into the Test Set's INSTRUMENT CONFIGURE screen to compensate for these losses.

Signal losses are measured using a built-in automated routine that runs on the Test Set's IBASIC controller. Losses can be calibrated at a discrete (single) frequency or over a frequency range. This is one routine included in a set of utility procedures called the RF TOOLS.

During the test, a calibrated signal goes through two 6-dB attenuators/pads (such as Mini-Circuits model NAT-6-60) and a short type-N male-to-male cable to establish a known reference point. The Test Set then prompts you to connect the device under test to measure the additional loss through that device. (The pads and cable are not part of the standard equipment shipped with the Test Set.)

Figure 3-1 shows how to load and run the RFTOOLS routines and select the desired insertion loss test.

**Figure 3-1 Loading and Running the Insertion Loss Test**

**1** Select ROM. →

**2** Select RFTOOLS. →

**3** Select Run Test. →

When the screen below appears.....

...use the knob to move the cursor and select either **Discrete Freq Insertion Loss** or **Swept Insertion Loss**. When run, the test prompts you to enter the necessary test frequency information and displays setup diagrams. Make the indicated connections and follow instructions as you are prompted by the program.

## Memory Cards

The slot on the front of the Test Set is used for memory cards. The slot is used for the following:

- Storage of save/recall registers
- Loading of software (either HP or self-written)
- Collecting data (only when using software)
- Upgrading firmware or software

## Memory Cards and Initialization

There are several types of memory cards available, and the following cards are used with the Test Set:

- SRAM: used for save/recall and data storage
- Flash ROM: used when upgrading firmware
- OTP (One-Time Programmable): used for HP software

Flash ROM cannot be used for collecting data and Save/Recall.

Data cannot be loaded on Flash RAM and OTP cards with the Test Set's memory card slot.

SRAM can be initialized with the Test Set.

### Initializing SRAM Cards for Save/Recall and Data Collection

1. Insert the SRAM card into the slot. If the card is uninitialized, a message will appear at the top of the display.
2. Press **Shift** and **IO Config** to display the I/O CONFIGURE screen.
3. Using the knob, locate the **FORMAT CARD** field.
4. Select the **FORMAT CARD** field. A prompt will appear at the top of the display. Pressing **Yes** will erase and initialize the card.

## Oscilloscope

The built-in 50 kHz oscilloscope provides

- multiple triggering formats (internal and external)
- single-shot and pre-trigger viewing for single events
- full marker capability with automatic level and time readout

Time/division, volts/division and vertical offset are displayed and can be changed using the front-panel knob.

Input to the Oscilloscope (SCOPE) is provided from various sources including direct inputs to the Audio Input and Modulation Input connectors. Oscilloscope functions are accessed from the AF Anl and SCOPE screens.

**Figure 3-2 Inputs and Filters for the Oscilloscope**

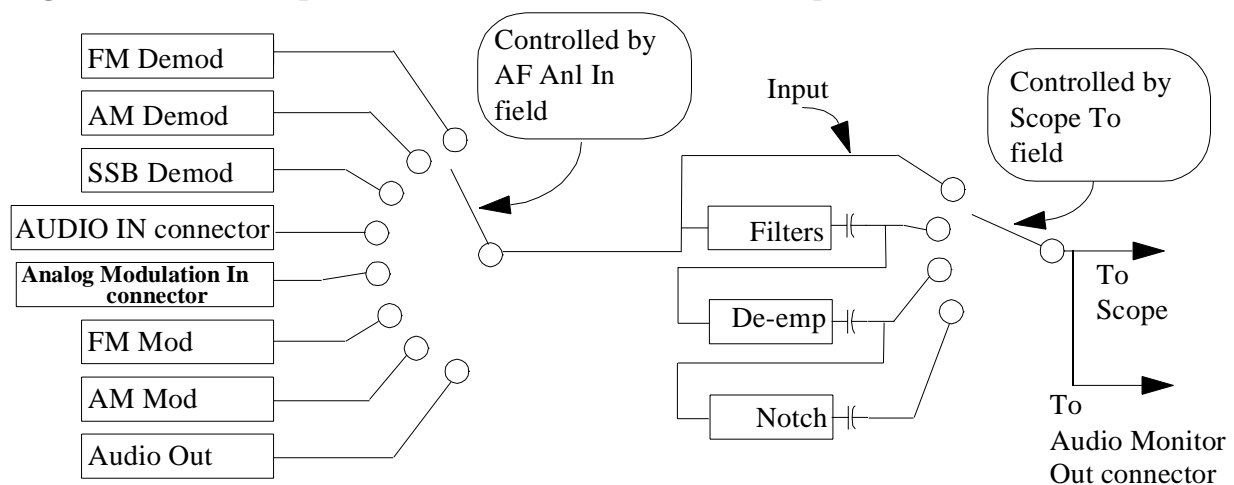

## Selecting the Oscilloscope's Input

1. Press **Shift**, then **RF Anl** (**AF Anl**) to select the **AF ANALYZER** screen.
2. Select the **AF Anl Input** field. A list of choices appears.
3. Select the desired input to the scope:
  - **FM Demod** for FM demodulated audio from input signals connected to the **RF IN/OUT** or **ANT IN** connectors.
  - **AM Demod** for AM demodulated audio from input signals connected to the **RF IN/OUT** or **ANT IN** connectors.
  - **SSB Demod** for SSB demodulated audio from input signals connected to the **RF IN/OUT** or **ANT IN** connectors.
  - **Audio In** for a signal connected to the **AUDIO IN** connector.
  - **Ext Mod** for a signal connected to the rear panel **MODULATION INPUT** connector.
  - **FM Mod** for the FM modulated audio from the **RF generator** section.
  - **AM Mod** for the AM modulated audio from the **RF generator** section.
  - **Audio Out** for the signal present at the **AUDIO OUT** connector.
4. The input to the oscilloscope is displayed on the **SCOPE** screen.

## Selecting the Oscilloscope's Filters

1. Press **Shift**, then **RF Anl** (**AF Anl**) to select the **AF ANALYZER** screen.
2. Select the **Scope To** field. A list of choices should appear.
3. Select the desired filtering for the signal:
  - **Input** if you want no filtering (dc coupled)
  - **Filters** to route the audio to the oscilloscope after passing through filters 1 and 2. (ac coupled)
  - **De-emp** to route the audio to the oscilloscope after passing through filters 1 and 2, and the de-emphasis circuitry.(ac coupled)
  - **Notch** to route the audio to the oscilloscope after passing through Filters 1 and 2, the de-emphasis circuitry, and notch filter circuitry. (ac coupled)

## Triggering the Oscilloscope

You can control following triggering features of the oscilloscope:

- Trigger: external or internal
- Automated or normal triggering
- Continuous or single shot triggering
- Trigger level
- Trigger delay

The oscilloscope is triggered using the `Trigger` menu. Select this menu with the following procedure:

1. Press `Shift`, then `Spec Anl (Scope)` to go to the `SCOPE` screen.
2. Select the `Controls` field, then choose `Trigger` from the list of choices.

## Using the Marker

The marker is used to help you make measurements with the oscilloscope. By repositioning the marker, you can measure the level and time.

The Marker is controlled using the `Marker` menu. Select this menu with the following procedure:

1. Press `Shift`, then `Spec Anl (Scope)` to go to the `SCOPE` screen.
2. Select the `Controls` field, then choose `Marker` from the list of choices.



## Online Help

The Test Set contains help screens which briefly identify the most commonly used features of the Test Set.

Access the help screens by pressing the **Help** key. Use the knob to select the Help Topic of interest.

Pressing the **Prev** key allows you to switch between the HELP screen and the previous screen you had accessed. This is particularly useful when you are following a procedure described in the HELP screen.

## Help Screen Display

**Figure 3-3 Help Screen Display**

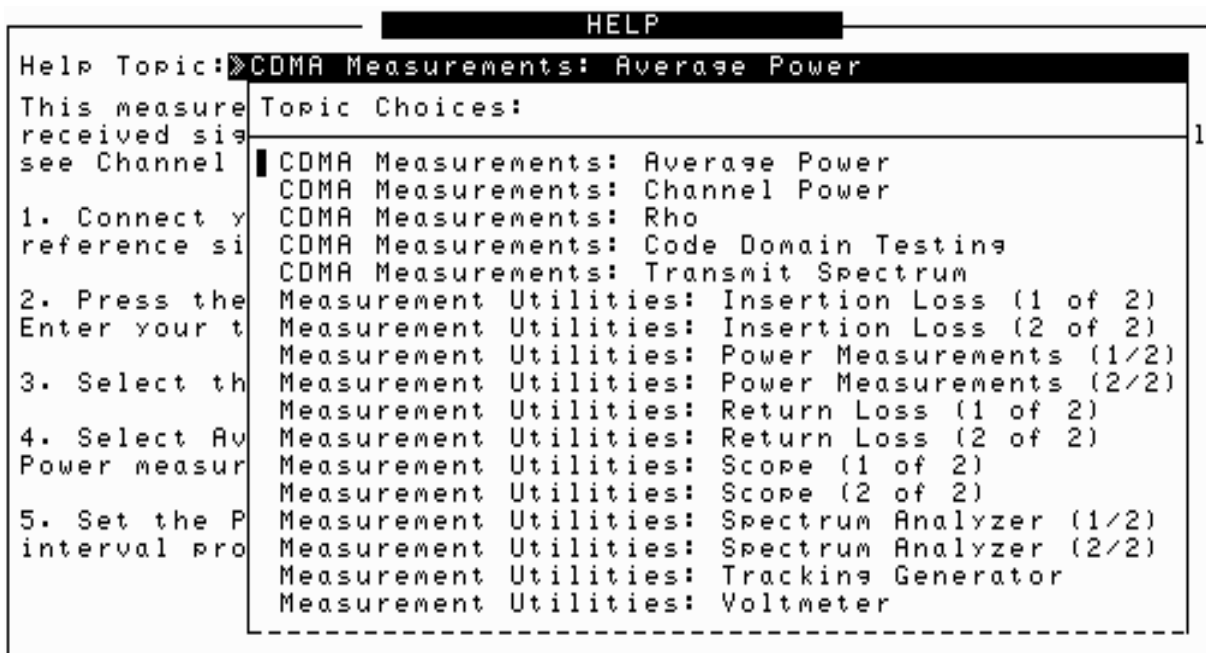

## Ports: HP-IB, Serial and Parallel

There are three types of data ports on the Test Set: HP-IB, Serial, and Parallel. They each have specific purposes.

### HP-IB Port

This port is provided on the Test Set for IEEE 488.2 communications. It is used to control the Test Set with an external IBASIC controller, or to control other HP-IB equipped devices.

This port can be used with an external programming device when writing programs, although it is also common to program the Test Set using a serial port.

The default address of the HP-IB port is 14. This is commonly used in IBASIC programs. An example command providing output to the port is **OUTPUT 714;"\*RST"**, which presets the Test Set.

It has two modes, which correspond to modes useful when programming the Test Set. `Talk&Listn` is the normal mode. Use `Control` only when you need to control HP-IB instruments external to the Test Set.

### Controlling the HP-IB Port

1. Press `Shift`, then the `Inst Config (I/O Config)` key to display the `I/O CONFIGURE` screen.
2. Set the address of the HP-IB port with the `HP-IB Adrs` field.
3. Use the `Mode` field to set the mode to either `Talk&Listn` or `Control`.

### Serial Ports

Three serial ports are available on the Test Set. Port 9 is used for printing, IBASIC control and data communications. Serial ports 10 and 11 are used only for data communications from IBASIC.

### Configuring Serial Ports

All serial ports are configured via the `I/O CONFIGURE` screen. Baud Rate, Parity, Data Length, Stop Length and Flow Control are all configured in this screen. Additionally, port 9 can be configured for IBASIC control in this screen.

1. Press `Shift`, then `Inst Config (I/O Config)` to go to the `I/O CONFIGURE` screen.
2. Select `Serial Port` to choose the port you want to configure.

3. Change the settings for the port as desired.

---

NOTE

Do not turn Flow Control on (set `Flow Cntl` to “Hardware” in the I/O CONFIGURE screen) for the serial port until you have a device attached to the port that can respond to the flow control communications.

Example: Assume you have a printer attached to Serial Port 9. Power is off to the printer. Before you start to run any IBASIC software (for example, the RFTOOLS program), you must make sure the printer is attached and power is on to the printer.

---

### Using Serial Ports for Printing

Serial Port 9 is the only serial port that can be used for printing. See “Printing” on page 61.

1. If you want to change the serial port configuration, see “Configuring Serial Port 9 for IBASIC Communications” on page 59. It is not necessary to change the `Serial_9 In` field.
2. Press `Shift`, then `Print` (Printer Config) to display the PRINTER CONFIGURE screen.
3. Select `Printer Port`. Choose `Serial 9` to direct the output to Serial Port 9.
4. Press `Print` to print the currently displayed screen.

### Configuring Serial Port 9 for IBASIC Communications

The internal connection to Serial Port 9 is controlled in the I/O CONFIGURE screen. The port has two purposes with IBASIC:

- `Inst`: Serial Port 9 is connected to a terminal (e.g. a PC running Windows Terminal program). IBASIC commands are input from the terminal and are used to control the Test Set.
  - `IBASIC`: Serial Port 9 is connected to a device that can communicate with an IBASIC program already running inside the Test Set. Typically used for input/output to a PC or other device.
1. Press `Shift`, then `Inst Config` (I/O Config) to go to the I/O CONFIGURE screen.
  2. Select `Serial_9 In` to toggle between `Inst` and `IBASIC`.

### Configuring Serial Ports 10 and 11

Serial Ports 10 and 11 are only configured via IBASIC commands. See the *Programmer's Guide* for commands which control these ports.

## Parallel Ports

There are two parallel ports on the Test Set.

Parallel Port 15 is the only parallel port that can be used for printing. It can be selected in the PRINTER CONFIGURATION screen.

Both parallel ports (Port 15 and Port 16) may be used for controlling a base station. The port can be put in an input or an output mode. The data is then written or read under IBASIC control. When in either of these modes, the printing function on Parallel Port 15 is disabled.

---

## Printing

You can print from the Test Set via Parallel Port 15, Serial Port 9, or the HP-IB port.

Note that data collection is not the same as printing. Data collection can only be done from a software program.

## Configuring the Test Set for Printing

1. Press **Shift**, then **Print** (Printer Config) to display the **PRINTER CONFIGURE** screen.
2. Select the **Model** field and choose the printer that most closely matches your printer.
3. Select the **Printer Port** field and choose the port you will connect the printer to. If necessary, use the **I/O CONFIGURE** screen to set up addresses and communication modes.
  - a. **SERIAL PORT 9:** This is the uppermost serial port. Configuration defaults are 9600, none, 8, 1, Xon/Xoff.
  - b. **HP-IB:** The HP-IB address (HP-IB Adrs) is set to printer address 701. Enter this number as 01. Set Mode to **CONTROL**. (The default address 14 is reserved for an external controller.)
  - c. **PARALLEL PORT:** There are two ports available. Port 15 (the printer port) is the uppermost port.
4. Connect the proper cable to the connector you selected.
  - **SERIAL PORT:** standard NULL MODEM cable.
  - **HP-IB:** HP-IB cable (such as HP 10833B)
  - **PARALLEL PORT:** parallel cable
5. Change the **FF** (form feed) and **Lines/Page** as needed.

## Printing a Screen

1. Configure the Test Set for Printing.
2. Go to the screen you want to print.
3. Press the **Hold** key if you want to temporarily stop the measurement. (Optional).
4. Press the **Print** key. Data will be sent to the printer.
5. To cancel the print, go to the **PRINTER CONFIGURE** screen and select **Abort Print**.

## Measuring Swept Return Loss

This procedure measures the return loss (VSWR) of an antenna using an IBASIC program that is in the Test Set's memory. An external directional bridge must be provided (such as an Eagle RLB 150X5 Option N5A or equivalent).

Press the Menu key to access the SOFTWARE MENU screen, and follow the instructions illustrated on the following pages.

**Figure 3-4 Loading and Running the Return Loss Program**

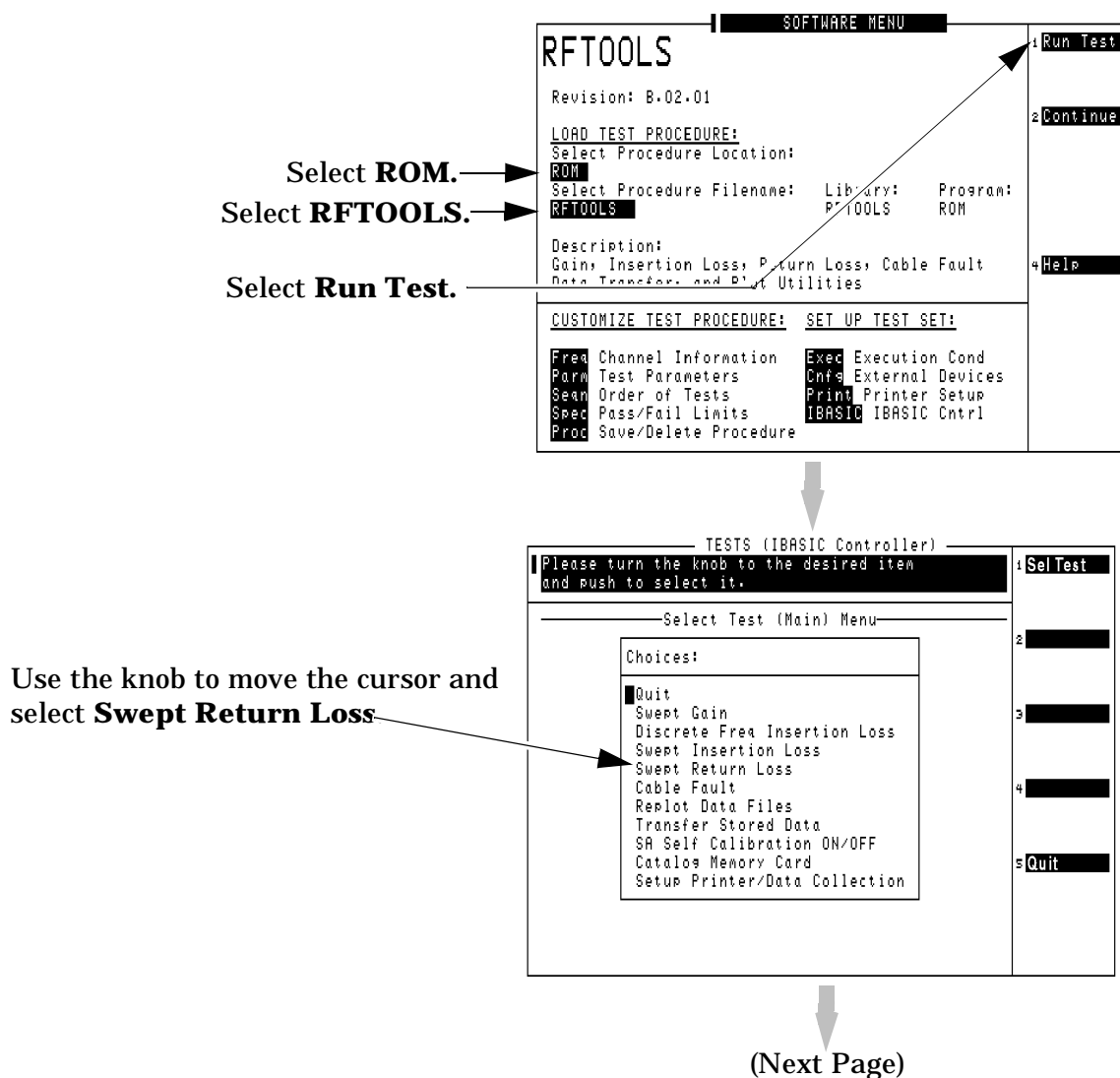

**Figure 3-5 Entering Swept Return Loss Measurement Information**

Enter the **Start** and **Stop Frequency** values for the measurement.

The **Max expected loss** value is used to determine the graphics scaling when the measurement is displayed.

The **DUPLEX OUT level** is adjustable to reduce the RF level used when measuring the loss of sensitive devices, and to minimize the amount of transmitted power during the test (if necessary).

Select **Begin Tst** (κ1) to continue.

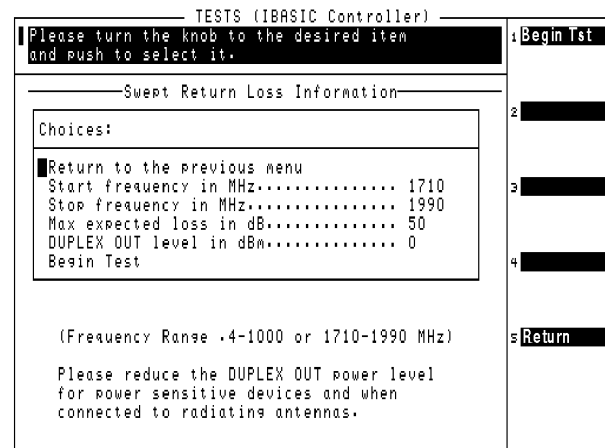

**Figure 3-6 Swept Return Loss Measurement Connections**

Two 6 dB attenuators (pads), two short cables, and the return loss bridge are used to establish a calibration reference **without the device under test connected**. Press **Proceed** (κ1) to continue.

As indicated by the NOTE on the drawing, your return loss bridge may be marked differently than shown.

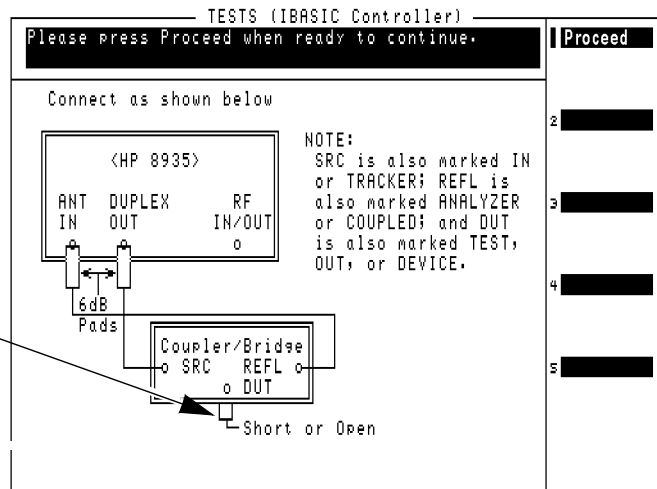

When measuring the swept return loss of a transmission line that is not terminated at an antenna, terminate the line into a 50Ω load.

After connecting your device under test, press **Proceed** (κ1) to make the measurement.

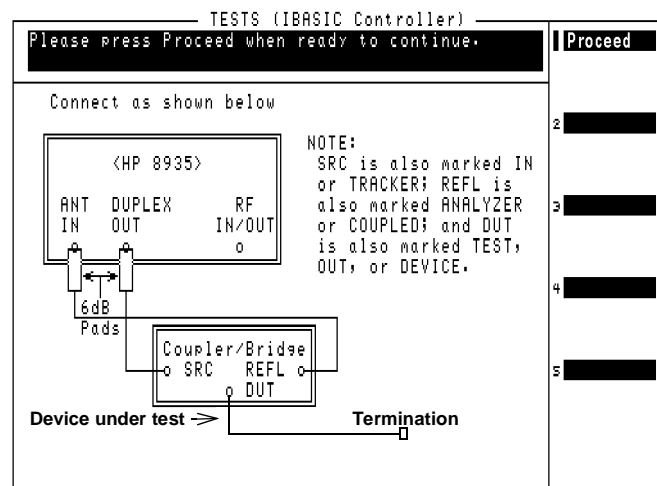

The plot in [Figure 3-7](#) is for a cellular band antenna, swept from 800 MHz to 999 MHz. The plot (and the text above it) indicates that the maximum return loss is at 885.4 MHz. This is the point where the antenna is radiating the maximum amount of signal being fed into it from the return loss bridge, and therefore the Test Set is receiving the least amount of reflected (returned) energy back.

**Figure 3-7** Swept Return Loss Measurement Results

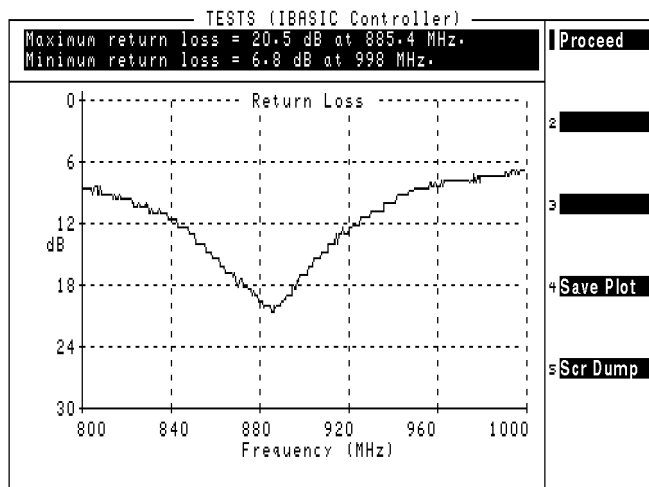

**Proceed** to the run the test again or to select a different test.

**Save Plot** to an initialized writeable PC card. (See ["Memory Cards"](#) on page 52.)

Perform a **Screen Dump** to print the screen to a connected printer. (See ["Printing"](#) on page 61.)



## Tracking Generator

The tracking generator is typically used for measuring return loss and insertion loss. It also allows for quick and accurate characterization of filters, duplexers, combiners, and RF to IF conversions. Broadband RF devices can be characterized with single sweeps due to the full-span sweep capability to 1 GHz. The tracking generator also includes amplitude and frequency offset. Output from the tracking generator are provided at either the RF IN/OUT or DUPLEX OUT connector.

### Using the Tracking Generator

To measure return loss, see "Measuring Swept Return Loss" on page 62. To measure insertion loss, see "Measuring Insertion Losses" on page 51.

Features of the tracking generator are listed below.

- **Sweep:** the start and stop frequencies of the sweep are determined by the spectrum analyzer's Main menu. The `Span` determines the band, and `Center Freq` defines the midpoint of the sweep.
- **Offset Freq:** sets the difference between the instantaneous frequency of the tracking generator and the center frequency of the spectrum analyzer. This value can be positive or negative.
- **Amplitude:** sets the amplitude of the signal.
- **Norm/Invert:** With `Norm`, the tracking generator sweeps from low to high frequencies. With `Invert`, it sweeps from high to low frequencies.

#### NOTE

The offset function is useful when looking at frequency translating devices, or anytime you need to sweep around a frequency while analyzing another. During normal operation, offset is set to 0.00.

**Figure 3-8** Spectrum Analyzer with Tracking Generator Controls Displayed

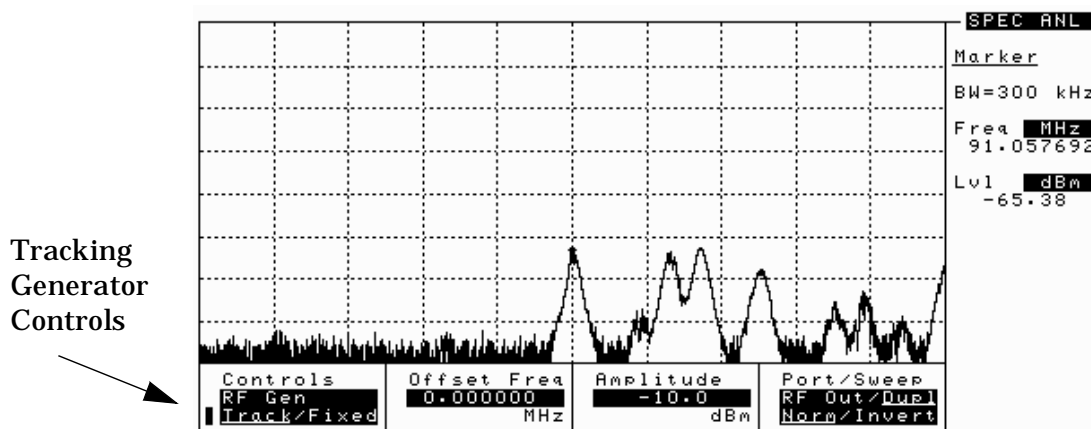

## User Keys

User keys instantly access instrument settings without using the knob. You can use user keys to move quickly between fields on the same screen, and to access field settings that are not normally available on the screen you are using. When the user key is pressed, the cursor instantly moves to, and selects, the assigned field.

Global user keys are used to access settings that are not available on the current screen. Three global user keys are available:  $k1'$ ,  $k2'$ , and  $k3'$ . (To use one of these keys, press **Shift**, then  $k1$ ,  $k2$ , or  $k3$ .)

Local user keys are used to move between settings on the screen that is currently displayed. Five local user keys are available for each screen:  $k1$ ,  $k2$ ,  $k3$ ,  $k4$ , and  $k5$ . You can assign these keys yourself, or use the factory preset assignments.

### Displaying the Pre-assigned Local User Keys

1. Press the **Shift** key.
2. Press the  $k4$  (Assign) key.
3. Press **Enter**. Now the factory preset keys are displayed.

### Assigning a Local User Key

1. Move the cursor to the field you want to assign to a user key.
2. Press the **Shift** key.
3. Press the  $k4$  (Assign) key.
4. Press the user key you want to assign to the field you chose. The number of the user key will appear beside the field when you move the cursor.

## Assigning a Global User Key

1. Move the cursor to the field you want to assign to a user key.
2. Press the **Shift** key.
3. Press the **κ4** (Assign) key.
4. Press the **Shift** key.
5. Press the user key you want to assign to the field you chose (**κ1**, **κ2**, or **κ3**). Global user keys are indicated as **k1'**, **k2'**, and **k3'** on the front panel to indicate that they are shifted functions. The number of the user key does not appear beside the field when using global user keys.

## To Release a User Key Assignment

Perform the same procedure for assigning a key, but instead of pressing the **κ4** (Assign) key, press the **κ5** (Release) key.

## Using Channel Numbers to Set Analyzer and Generator Frequencies

RF analyzer and RF generator frequencies can be entered by channel number (the default setting) or by discrete frequencies (in MHz). The RF Display field on the INSTRUMENT CONFIGURE screen controls which way frequencies are entered. This screen is accessed by pressing the Inst Config key.

If the RF Display field is set to Chan for channel tuning, you also need to set the RF Chan Std field to LS AMPS to tell the Test Set you are testing Land (base) Station AMPS radios. This automatically sets the correct 45 MHz frequency offset needed to generate reverse channel signals and analyze forward channel signals for an AMPS base station.

If you do not know the channel number of your base station, but know the transmit and receive frequencies, set the RF Display field to Freq. You can then enter these frequencies directly for the RF generator and RF analyzer during tests.

**Figure 3-9 Configuration to Use Channel Numbers for RF Generator and Analyzer Settings**

Set the **RF Display** field to **Chan** to turn on channel tuning.

Select the **RF Chan Std** field to display a list of system types.....

..and then select **LS AMPS** for testing AMPS base stations.

INSTRUMENT CONFIGURE				
Date	RF Level	RF Display	Ref Select	Firmware
92397	Offset	Freq/Chan	Auto	Y.03.04
MMDDYY	On/Off			
Time	RF In/Out	RF Chan Std	Ext Ref In	Total RAM
15.22	dB	N AMER PCS	10 MHz	928 kB
HH.MM		Choices:		
Beeper	Duplex Out	N AMER PCS	Frame Clock	Serial No.
On/Off	dB	KOR PCS 0	Output	US37120053
Display	Antenna In	KOR PCS 1	2.00 s	
User Mssgs	dB	MS AMPS		
Yes/No		LS AMPS	Opt CDMA TB	
Range Hold		MSL NAMPS	Internal	
Auto All		MSM NAMPS		
Hold All		MSU NAMPS		
State:Auto		LSL NAMPS		
		LSM NAMPS		
Notch Coupl				
RFGen1/None				
RFGen Volts				
50 ohm/enf				

## RF Chan and Tune Freq Fields

---

**NOTE**

---

All of the test procedures in this document assume you are using channel tuning. If you are using frequency tuning, enter the frequency in the appropriate field(s).

When you use **channel tuning**, the RF ANALYZER and RF GENERATOR screens displays an RF Channel field for entering the channel to tune to or generate.

When you use **frequency tuning**, the RF ANALYZER screen replaces the RF Channel field with the Tune Freq field for direct frequency entry. The RF GENERATOR screen replaces the RF Channel field with the RF Gen Freq field. For AMPS Base Station tests, remember that there should always be a 45 MHz separation between the transmit and receive frequencies (transmit frequency is 45 MHz greater than the receive frequency).

## Voltmeter

A voltmeter is available in the Test Set, and can measure low level dc or ac voltages. The input to the voltmeter is controlled by the AF Anl In field in the AF ANALYZER screen.

---

### CAUTION

Do not exceed the rated input to the Test Set for the DC Level and AC Level measurements.

The connector best suited to making ac Level and dc Level measurements is the AUDIO IN port.

## Measuring AC Level and DC Level

1. Press **Shift**, then **RF Anl** (AF Anl) to go to the AF ANALYZER screen.
2. Select **AF Anl In** and choose **Audio In**.
3. Select **Audio In Lo** and choose **Gnd**. This sets the AUDIO IN LO port to ground, which allows you to measure voltage at the AUDIO IN HI port.
4. Attach a probe (for example a 1:1 oscilloscope probe) to the AUDIO IN HI connector.
5. AC Level is displayed. To change to DC Level, select the **AF Freq** measurement and choose **DC Level** from the displayed list of choices.

---

## A

- AC level
  - measuring, 70
- AC volts
  - measuring, 70
- AF Anl Input
  - field, 54
- AF connections, 32
- AMPS Base Stations
  - manual testing, 29
- AMPS testing, 18
- AMPS tests
  - receiver sensitivity (SINAD), 42
  - receiver squelch threshold, 45
  - transmitter data deviation, 38
  - transmitter frequency
    - error/offset and power, 34
  - transmitter maximum voice deviation, 40
  - transmitter SAT frequency and deviation, 36
- AMPS Tests listed, 30
- analyzer and generator
  - frequencies
    - using channel numbers, 68
- Analyzing FM Carrier, 26
- ANT IN port
  - overpower, 30
- Antenna In field, 33
- ANTENNA IN port
  - losses, 33
- Assembly Level Repair Manual
  - calibration, 22
  - assigning global user keys, 67
  - assigning local user keys, 66
- AUDIO IN port, 32
- AUDIO OUT port, 32
- automatic operation, 21
- Available AMPS tests, 30

## B

- Base Station connections, 32
- batteries
  - replacing, 18
- beeper, 50

## C

- cable losses
  - compensating, 33
- cables
  - for printing, 61
  - HP-IB, 61
  - Null Modem, 61
- calibration
  - Assembly Level Repair Manual, 22
  - when you change a module, 22
- call center
  - Europe, 19
  - U.S., 19
- Canada HP Direct, 19
- CD-ROM
  - documentation, 20
- Cell Band CDMA testing, 18
- change battery procedure, 18
- channel numbers
  - using, to set analyzer and generator frequencies, 68
- congratulations, 27
- connections
  - base station, 32
  - FM Loopback test, 23
- conventions used in his manual, 5

---

## D

Data Deviation test, [38](#)  
DC level  
  measuring, [70](#)  
DC volts  
  measuring, [70](#)  
Displaying an FM Carrier, [26](#)  
Duplex Out field, [33](#)  
DUPLEX OUT port, [32](#)  
  losses, [33](#)  
  overpower, [30](#)

## E

entering test system losses and  
  gains, [33](#)  
European Call Center, [19](#)

## F

fields  
  selecting, [24](#)  
FM Carrier  
  analyzing, [26](#)  
  displaying, [26](#)  
FM Loopback test, [23](#)  
FM Signal  
  displaying, [23](#)  
FM signal  
  generating, [24](#)  
frequencies  
  setting analyzer and generator,  
  [68](#)  
Frequency Error test, [34](#)



---

## G

generating an FM signal, [24](#)  
Getting Help, [19](#)  
Getting Started, [17](#)  
global user keys, [66](#)  
    assigning, [67](#)  
    releasing, [67](#)

## H

help  
    how to get, [19](#)  
    online, [57](#)  
    screen display, [57](#)  
hot keys  
    setting, [66](#)  
HP Direct  
    Canada, [19](#)  
    Korea, [19](#)  
HP-IB communications  
    via the serial port, [59](#)  
HP-IB controller  
    internal to the Test Set, [21](#)  
HP-IB port  
    controlling, [58](#)  
    modes, [58](#)

## I

IBASIC Programs, [21](#)  
in this manual, [5](#)  
INSTRUMENT CONFIGURE  
    screen, [33](#)

---

## K

k1, k2, k3, k4, k5  
  local user keys, 66  
k1', k2', k3'  
  global user keys, 66  
knob  
  using, 24  
Korea HP Direct, 19

## L

local user keys, 66  
  assigning, 66  
  preassigned, 66  
  releasing, 67  
Loopback Test, 23

## M

manual operation, 21  
manual testing  
  AMPS base stations, 29  
maximizing measurement  
  accuracy, 22  
measurement accuracy  
  maximizing, 22  
measurement port, 30  
measuring path losses and gains,  
  31  
memory cards, 52  
modes of the Test Set, 21

**O**

oscilloscope, 53  
  features, 53  
  filters and inputs, 53  
  marker, 56  
  selecting the filters, 54  
  selecting the input, 54  
  triggering, 55

**P**

parallel port  
  input and output modes, 60  
  ports 15 and 16, 60  
path losses, 33  
  measuring, 31  
PCMCIA card, 52  
  Flash ROM, 52  
  initializing, 52  
  OTP, 52  
  SRAM, 52  
PCS CDMA testing, 18  
port  
  HP-IB, 58  
  HP-IB, serial, parallel, 58  
  measuring AC or DC level, 70  
  printing via the serial port, 59  
  serial, 58  
Power  
  measurement port, 30  
Power calibration/compensation, 22  
preassigned local user keys, 66  
printing, 61  
  and data collection, 61  
  cables, 61  
  configuring the Test Set, 61  
  FF (Form Feed), 61  
  how to print a screen, 61  
  HP-IB, 61  
  lines per page, 61  
  parallel port, 61  
  ports, 61  
  serial port 9, 61  
  via the serial port, 59  
probe  
  measuring AC or DC level, 70  
Product Description, 18  
Programmer's Guide, 21  
purchased software, 21

**R**

RAM  
  backing up, 18  
  read me first, 31  
Receiver Sensitivity test, 42  
receiver squelch threshold, 45  
return loss, 62  
RF connections, 32  
RF In/Out field, 33  
RF IN/OUT port, 32  
  losses, 33  
  measuring power, 30  
  overpower, 30  
RF Level Offset field, 33

---

## S

- sales offices, [19](#)
- SAT Deviation test, [36](#)
- SAT Frequency test, [36](#)
- screens
  - selecting, [24](#)
- serial port, [58](#)
  - configuring, [58](#)
  - configuring for HP-IB communications, [59](#)
  - port 9, configuring for HP-IB communications, [59](#)
  - port 9, configuring for printing, [59](#)
  - ports 10 and 11, [59](#)
  - using for printing, [59](#)
- signal losses and gains
  - compensating, [33](#)
- SINAD test, [42](#)
- software
  - manufacturer-specific, [21](#)
  - purchased, [21](#)
- Spectrum Analyzer, [26](#)
- squellch threshold, [45](#)
- SRAM card
  - initializing, [52](#)
- systems
  - AMPS, [18](#)
  - CDMA, [18](#)
  - PCS CDMA, [18](#)

## T

- temperature compensation
  - Pwr Zero, [22](#)
- test interface connections, [32](#)
- Test Set
  - documents included, [20](#)
  - what's in the box, [20](#)
- tips for selecting screens and fields, [24](#)
- TMO web site, [19](#)
- tools contained in the Test Set, [18](#)
- tracking generator, [65](#)
  - controls display, [65](#)
  - offset frequency, [65](#)
  - using, [65](#)
- TX Power, [30](#)
- TX Power test, [34](#)

## U

- U.S. Call Center, [19](#)
- user keys
  - global, [66](#)
  - local, [66](#)
  - releasing, [67](#)
  - setting, [66](#)
- Utility Procedures, [49](#)

---

## V

Voice Deviation (max) test, [40](#)  
voltmeter, [70](#)  
  connector, [70](#)  
volume  
  controlling beeper, [50](#)

## W

web site  
  TMO, [19](#)  
what to do next, [27](#)  
What's Included with this Test  
  Set, [20](#)  
www.tmo.hp.com, [19](#)